

## LED Digital Bed-lighting Sensor Strip



CL-CDA



CL-CDD

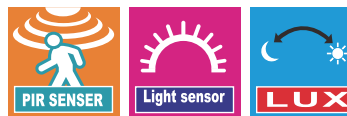

CL-CDG

OR

| Model:              | CL-CDA-1       | CL-CDA-2       | CL-CDD-1       | CL-CDD-2       | CL-CDG              |
|---------------------|----------------|----------------|----------------|----------------|---------------------|
| Voltage:            | DC12V          | DC12V          | DC12V          | DC12V          | DC 5V               |
| Power(W/m):         | 3              | 6              | 3              | 6              | 2.4                 |
| Body Material:      | PC             | PC             | PC             | PC             | PC                  |
| Led Type:           | 2835           | 2835           | 2835           | 2835           | 2835                |
| Led Qty(LED/m):     | 30             | 30             | 30             | 30             | 30                  |
| Luminous Flux(lm):  | 200 ± 10%      | 400 ± 10%      | 200 ± 10%      | 400 ± 10%      | 200 ± 10%           |
| CRI(Ra):            | >80            | >80            | >80            | >80            | >80                 |
| CCT(K):             | 3000/4000/6000 | 3000/4000/6000 | 3000/4000/6000 | 3000/4000/6000 | 3000/4000/6000      |
| Strips length(m):   | 1.2m *1        | 1.2m *2        | 1.2m *1        | 1.2m *2        | 1.2m *1             |
| Sensor Mode:        | PIR sensor     | PIR sensor     | PIR sensor     | PIR sensor     | PIR sensor          |
| Sensor Distance(m): | 2-5            | 2-5            | 2-5            | 2-5            | 2-5                 |
| Delay Time:         | 30s-6Min       | 30s-6Min       | 30s/130s/380s  | 30s/130s/380s  | 15s/2Min/5Min/10Min |

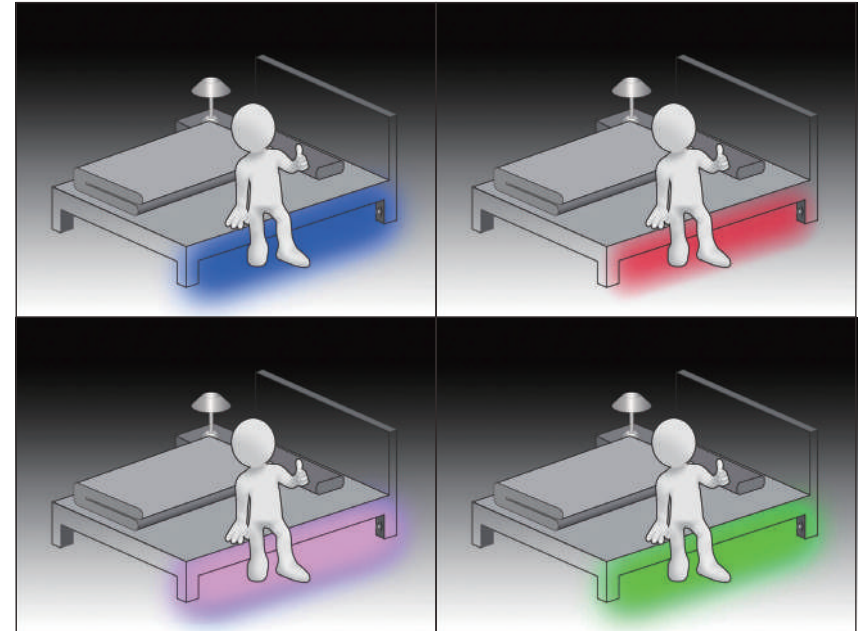
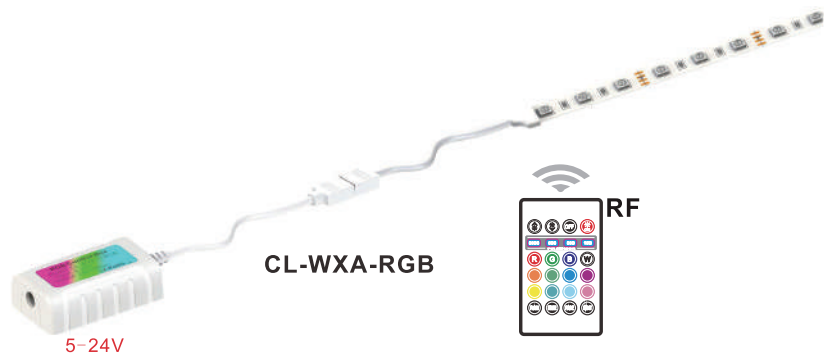
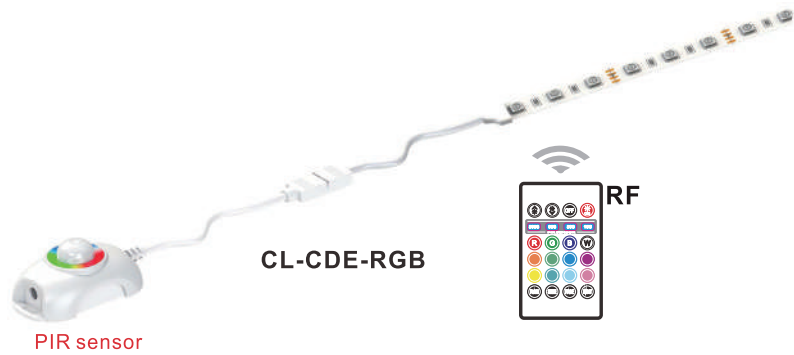
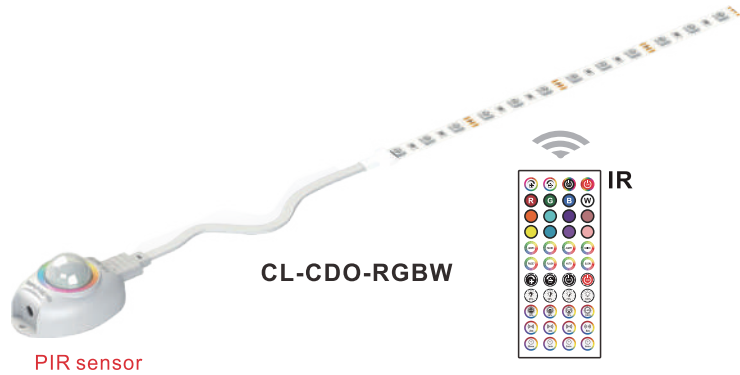

| Model:            | CL-CDO-RGBW   | CL-CDE-RGB    | CL-WXA-RGB |
|-------------------|---------------|---------------|------------|
| Voltage:          | DC12V         | DC12V         | DC12V      |
| Power(W/m):       | 6/12          | 6/12          | 6/12       |
| Body Material:    | PC            | PC            | PC         |
| Led Type:         | 5050+2835     | 5050          | 5050       |
| Led Qty(LED/m):   | 30/60         | 30/60         | 30/60      |
| Led Color:        | RGB           | RGB           | RGB        |
| Strips length(m): | 1.5/2/3/5     | 1.5/3/5       | 1.5/3/5    |
| Sensor Mode:      | PIR sensor+IR | PIR sensor+RF | RF         |
| Product Size(mm): | .....         | 64*36.5*26.5  | 48*29*14.5 |

# LED Motion Sensor Strip



CL-CDB



CL-CDK

- Human body and light sensor switch
- Sensor is fixed by using magnet, easy to use
- Lithium battery for power supply
- Apply use android phone charger



| Model:              | CL-CDB-1          | CL-CDK            |
|---------------------|-------------------|-------------------|
| Power Supply:       | 3.7V 1000mAh      | 3.7V 1500mAh      |
| Power(W):           | 2.4               | 2.4               |
| Body Material:      | PC                | PC                |
| Led Type:           | 2835              | 2835              |
| Led Qty(LED/m):     | 30                | 30                |
| Luminous Flux(lm):  | 180 ± 10%         | 180 ± 10%         |
| CRI(Ra):            | >80               | >80               |
| CCT(K):             | 3000/4000/6000    | 3000/4000/6000    |
| Sensor Distance(m): | 2-5               | 2-5               |
| Strips length(m):   | 1                 | 1                 |
| Sensor Mode:        | PIR sensor+Switch | PIR sensor+Switch |
| Delay Time:         | 30s               | 30s               |
| Charging Time(h):   | 2.5~3.5           | 4~5               |
| Working Time(h):    | ≥2.5              | ≥4                |



**CL-CDB-RGB**



**CL-CDB-RGBW**



**CL-CDB-W**



| Model:              | CL-CDB-RGB        | CL-CDB-RGBW       | CL-CDB-W             |
|---------------------|-------------------|-------------------|----------------------|
| Power Supply:       | 3.7V 1000mAh      | 3.7V 1000mAh      | 3.7V 1000mAh         |
| Power(W):           | 2.4               | 2.4               | 2.4                  |
| Body Material:      | PC                | PC                | PC                   |
| Led Type:           | 5050              | 5050              | 5050 or 2835         |
| Led Qty(LED/m):     | 30                | 60                | 30                   |
| Work Illumination:  | 2~5Lux            | 2~5Lux            | 2~5Lux               |
| Luminous Flux(lm):  | /                 | /                 | 180±10%              |
| CRI(Ra):            | /                 | /                 | >80                  |
| CCT(K):             | RGB               | RGB+W             | 3000/4000/6000/R/G/B |
| Sensor Distance(m): | 3~5               | 3~5               | 3~5                  |
| Strips length(m):   | 1                 | 1                 | 1                    |
| Sensor Mode:        | PIR sensor+Switch | PIR sensor+Switch | PIR sensor+Switch    |
| Delay Time:         | 15s/130s/380s     | 15s/130s/380s     | 15s/130s/380s        |
| Charging Time(h):   | 2~3               | 2~3               | 2~3                  |
| Working Time(h):    | 2~2.5             | 2~2.5             | 2~2.5                |





**CL-CDC**  
4\*AAA BATTERY



**CL-CDH**  
2\*AA BATTERY



| Model:              | CL-CDC-1          | CL-CDH-1          |
|---------------------|-------------------|-------------------|
| Power Supply:       | 4*AAA             | 2*AA              |
| Power(W):           | 2.4               | 1.5               |
| Body Material:      | ABS+PC            | ABS+PC            |
| Led Type:           | 2835              | 2835              |
| Led Qty(LED/m):     | 30                | 30                |
| Luminous Flux(lm):  | 180 ± 10%         | 150 ± 10%         |
| CRI(Ra):            | >80               | >80               |
| CCT(K):             | 3000/4000/6000    | 3000/4000/6000    |
| Sensor Distance(m): | 2-5               | 2-5               |
| Strips length(m):   | 1                 | 1                 |
| Sensor Mode:        | PIR sensor+Switch | PIR sensor+Switch |
| Delay Time:         | 15s               | 15s               |
| Working Time(h):    | ≥2.5              | ≥2.5              |

# Auto Sensing LED Portable Light



**CL-CDF-S**



Can use with led strip  
**CL-CDF-1**



**Flashlight function**



**Can be used as ambient light**

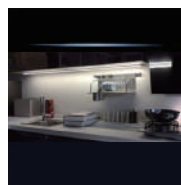

**with one led strip**



- Human body and light sensor switch
- Dimmable from 8%-100%
- Lithium battery for power supply
- Apply use android phone charger

| Model:              | CL-CDF-S          | CL-CDF-1          |
|---------------------|-------------------|-------------------|
| Power Supply:       | 3.7V 1500mAh      | 3.7V 1500mAh      |
| Power(W):           | 0.8               | 2.4               |
| Body Material:      | ABS               | ABS               |
| Led Type:           | 2835              | 2835              |
| Led Qty(pcs):       | 2                 | 30                |
| Luminous Flux(lm):  | 60±5%             | 180±10%           |
| CRI(Ra):            | >80               | >80               |
| CCT(K):             | 3000/4000/6000    | 3000/4000/6000    |
| Sensor Distance(m): | 2-5               | 2-5               |
| Product Size(mm):   | 132.5*38.5*31     | 132.5*38.5*31     |
| Sensor Mode:        | PIR sensor+Switch | PIR sensor+Switch |
| Delay Time:         | 15s               | 15s               |
| Charging Time(h):   | 4~5               | 4~5               |
| Working Time(h):    | ≥8                | ≥2.5              |

# LED Night Light — PIR Sensor

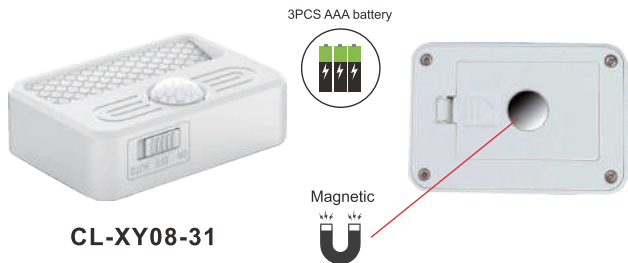
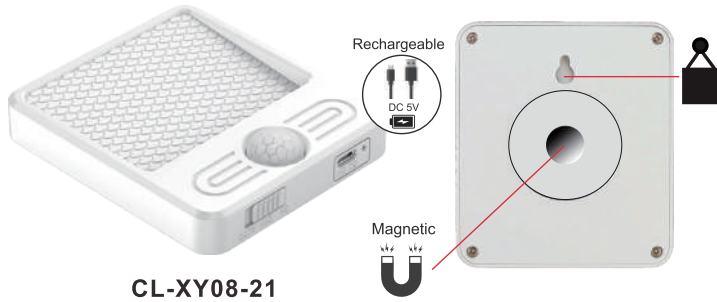
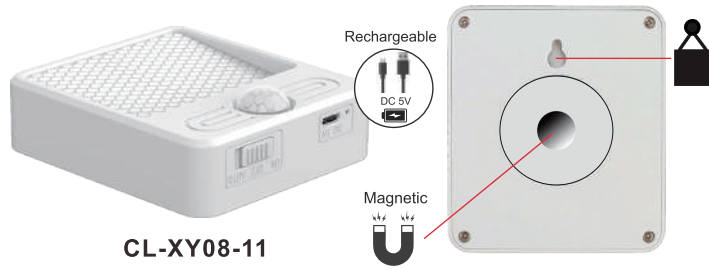

| Model:              | CL-XY08-11     | CL-XY08-21     | CL-XY08-31     |
|---------------------|----------------|----------------|----------------|
| Power Supply:       | 3.7V 1200mAh   | 3.7V 1000mAh   | 3*AAA          |
| Power(W):           | 0.7            | 0.7            | 0.5            |
| Body Material:      | ABS            | ABS            | ABS            |
| Led Type:           | 2835           | 2835           | 2835           |
| Led Qty(pcs):       | 6              | 6              | 6              |
| Luminous Flux(lm):  | 25 ± 5%        | 25 ± 5%        | 20 ± 5%        |
| CRI(Ra):            | >80            | >80            | >80            |
| CCT(K):             | 3000/4000/6000 | 3000/4000/6000 | 3000/4000/6000 |
| Sensor Distance(m): | 2~5            | 2~5            | 2~5            |
| Product Size(mm):   | 91*80*24.5     | 91*80*14.5     | 55*80*23       |
| Sensor Mode:        | PIR sensor     | PIR sensor     | PIR sensor     |
| Delay Time:         | 30s            | 30s            | 30s            |
| Switch Mode:        | ON/OFF/AUTO    | ON/OFF/AUTO    | ON/OFF/AUTO    |
| Charging Time(h):   | 3~4            | 2~3            | /              |
| Working Time(h):    | ≥10            | ≥8             | ≥8             |



**CL-XYD-A**  
3 x AAA Battery



**CL-XYD-L**  
Lithium Battery



**CL-XYD-G**  
3 x AAA Battery

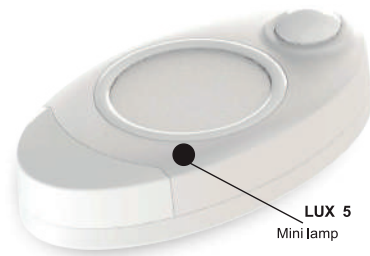

**CL-BDA**  
3.0V(CR2450 button cell)



| Model:              | CL-XYD-A       | CL-XYD-L       | CL-XYD-G       | CL-BDA                 |
|---------------------|----------------|----------------|----------------|------------------------|
| Power Supply:       | 3*AAA          | 3.7V 600mAh    | 3*AAA          | 3V(CR2450 Button Cell) |
| Power(W):           | 0.5            | 0.5            | 0.5            | 0.2                    |
| Body Material:      | ABS+PC         | ABS+PC         | ABS+PC         | ABS+PC                 |
| Led Type:           | 2835           | 2835           | 2835           | 2835                   |
| Led Qty(pcs):       | 6              | 6              | 6              | 1                      |
| Luminous Flux(lm):  | 30 ± 5%        | 30 ± 5%        | 30 ± 5%        | 25 ± 5%                |
| CRI(Ra):            | >80            | >80            | >80            | >80                    |
| CCT(K):             | 3000/4000/6000 | 3000/4000/6000 | 3000/4000/6000 | 3000/4000/6000         |
| Sensor Distance(m): | 2-5            | 2-5            | 2-5            | 2-5                    |
| Product Size(mm):   | Φ80*26.5       | Φ80*23         | Φ72*22         | 54*31*14               |
| Sensor Mode:        | PIR sensor     | PIR sensor     | PIR sensor     | PIR sensor             |
| Delay Time:         | 30s            | 30s            | 30s            | 15s                    |
| Working Time(h):    | ≥8             | ≥6             | ≥8             | ≥8                     |





**CL-XYD-C**

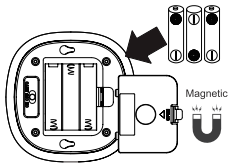

**CL-XYD-D**

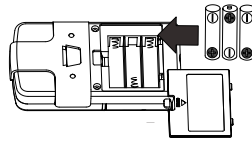

**CL-XYD-E**

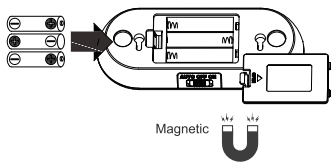

**CL-XYD-F**

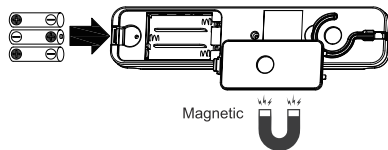

Installation on: storage room, cabinet, corridor, entrance.



| Model:              | CL-XYD-C       | CL-XYD-D       | CL-XYD-E       | CL-XYD-F       |
|---------------------|----------------|----------------|----------------|----------------|
| Power Supply:       | 3*AAA          | 3*AAA          | 3*AAA          | 3*AAA          |
| Power(W):           | 0.5            | 0.5            | 0.5            | 0.5            |
| Body Material:      | ABS+PC         | ABS+PC         | ABS+PC         | ABS+PC         |
| Led Type:           | 2835           | 2835           | 2835           | 2835           |
| Led Qty(pcs):       | 8              | 7              | 6              | 8              |
| Luminous Flux(lm):  | 25±5%          | 40±5%          | 35±5%          | 35±5%          |
| CRI(Ra):            | >80            | >80            | >80            | >80            |
| CCT(K):             | 3000/4000/6000 | 3000/4000/6000 | 3000/4000/6000 | 3000/4000/6000 |
| Sensor Distance(m): | 2-5            | 2-5            | 2-5            | 2-5            |
| Product Size(mm):   | 88*88*36       | 118*65*31      | 140*58*33      | 200*42*36.5    |
| Sensor Mode:        | PIR sensor     | PIR sensor     | PIR sensor     | PIR sensor     |
| Delay Time:         | 30s            | 30s            | 30s            | 30s            |
| Working Time(h):    | ≥8             | ≥8             | ≥8             | ≥8             |



**CL-CG21**  
3 x AAA Battery



**CL-CG22**  
3 x AA Battery



**CL-XY09**  
4 x AA Battery



Rechargeable

**CL-XY10-10**  
Lithium Battery



**CL-XY10-20**  
4 x AA Battery

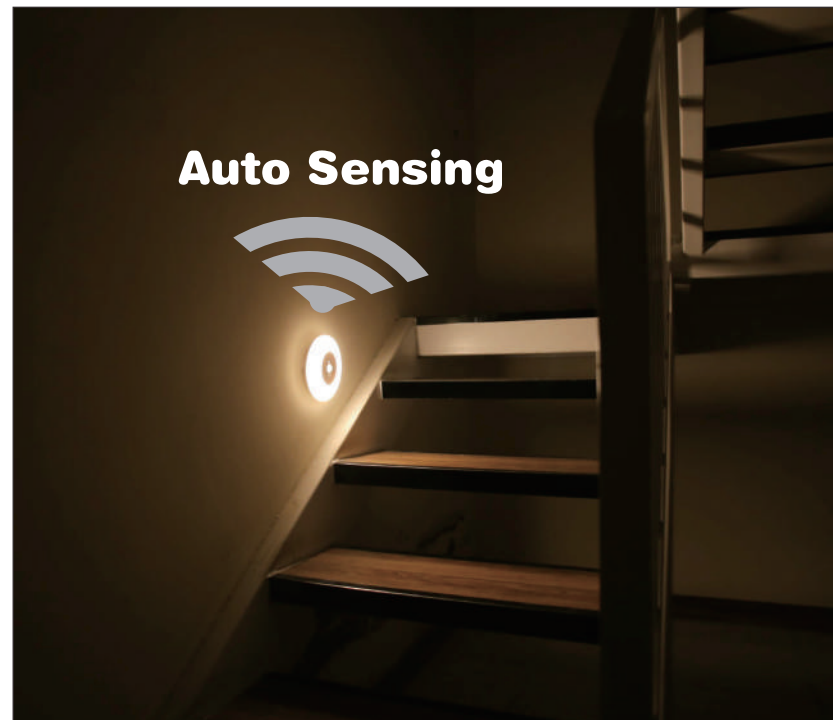

| Model:              | CL-CG21        | CL-CG22        | CL-XY09        | CL-XY10-10     | CL-XY10-20     |
|---------------------|----------------|----------------|----------------|----------------|----------------|
| Power Supply:       | 3*AAA          | 3*AA           | 4*AA           | 3.7V 2000mAh   | 4*AA           |
| Power(W):           | 0.4            | 0.7            | 1              | 1              | 1              |
| Body Material:      | ABS+PC         | ABS+PC         | ABS+PC         | ABS+PC         | ABS+PC         |
| Led Type:           | 2835           | 2835           | 2835           | 2835           | 2835           |
| Led Qty(pcs):       | 19             | 21             | 48             | 48             | 48             |
| Luminous Flux(lm):  | 40±5%          | 70±5%          | 110±5%         | 90±5%          | 90±5%          |
| CRI(Ra):            | >80            | >80            | >80            | >80            | >80            |
| CCT(K):             | 3000/4000/6000 | 3000/4000/6000 | 3000/4000/6000 | 3000/4000/6000 | 3000/4000/6000 |
| Sensor Distance(m): | 2-5            | 2-5            | 2-5            | 2-5            | 2-5            |
| Product Size(mm):   | 300*22*21.5    | Φ26*260        | 150*150*34.5   | Φ150*41        | Φ150*42        |
| Sensor Mode:        | PIR sensor     | PIR sensor     | PIR sensor     | PIR sensor     | PIR sensor     |
| Delay Time:         | 30s            | 30s            | 30s            | 30s            | 30s            |
| Working Time(h):    | ≥8             | ≥8             | ≥8             | ≥8             | ≥8             |

NEW

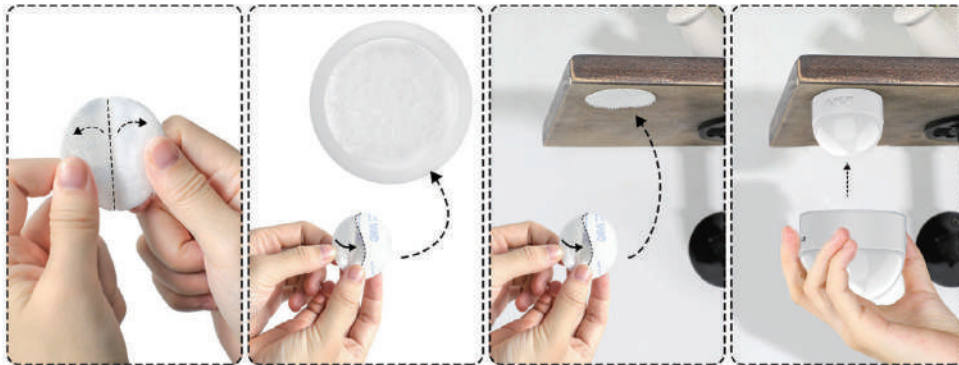

|                    |                           |
|--------------------|---------------------------|
| <b>Model:</b>      | <b>CL-XY11</b>            |
| Power Supply:      | 3.7V 1200mAh              |
| Power(W):          | 0.5                       |
| Body Material:     | ABS+PC                    |
| Led Type:          | 2835+5050RGB              |
| Led Qty(pcs):      | 5050RGB(3PCS)+2835(12PCS) |
| Luminous Flux(lm): | 40Lm±10%                  |
| CRI(Ra):           | >80                       |
| CCT(K):            | 3000K/4000K/6000K         |
| Product Size(mm):  | Ø78.2*67mm                |

# LED Cabinet Light

MAGNETIC INDUCTION

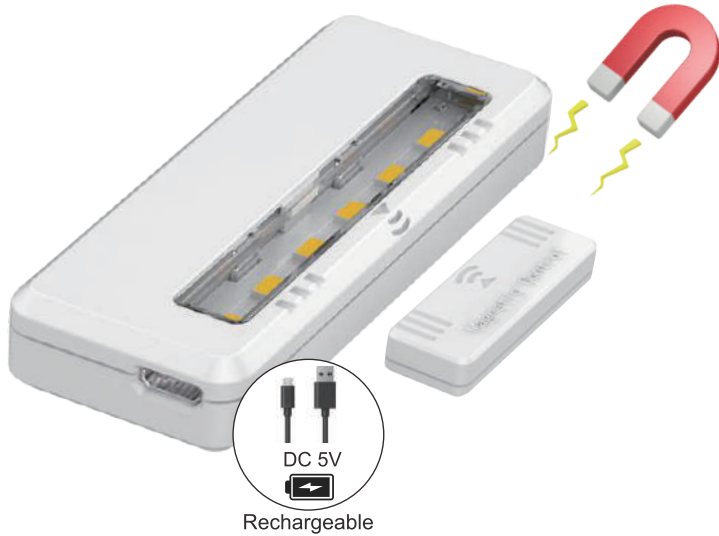

Open door, light on; Close door, light off.



Little sensor lights, can be installed on the door, aisle, and other places!

**CL-CGM-A**



2 x AAA Battery

**CL-CGM-L**



lithium battery

**CL-CGM-K**



lithium battery

| Model:               | CL-CGM-A         | CL-CGM-L         | CL-CGM-K         |
|----------------------|------------------|------------------|------------------|
| Power Supply:        | 2*AAA            | 3.7V 330mAh      | 3.7V 330mAh      |
| Power(W):            | 0.5              | 0.5              | 0.8              |
| Body Material:       | ABS+PC           | ABS+PC           | ABS+PC           |
| Led Type:            | 2835             | 2835             | 2835             |
| Led Qty(pcs):        | 6                | 6                | 12               |
| Luminous Flux(lm):   | 35±5%            | 35±5%            | 50±5%            |
| CRI(Ra):             | >80              | >80              | >80              |
| CCT(K):              | 3000/4000/6000   | 3000/4000/6000   | 3000/4000/6000   |
| Sensor Distance(cm): | 1-2              | 1-2              | 1-2              |
| Product Size(mm):    | 65*43*15         | 65*29*12         | 118*29*12        |
| Sensor Mode:         | Magnetic control | Magnetic control | Magnetic control |
| Charging Time(h):    | /                | 1                | 1                |
| Working Time(h):     | ≥6               | ≥3               | ≥2               |



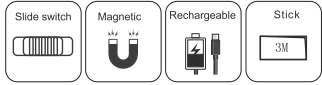

**CL-CG15-51**

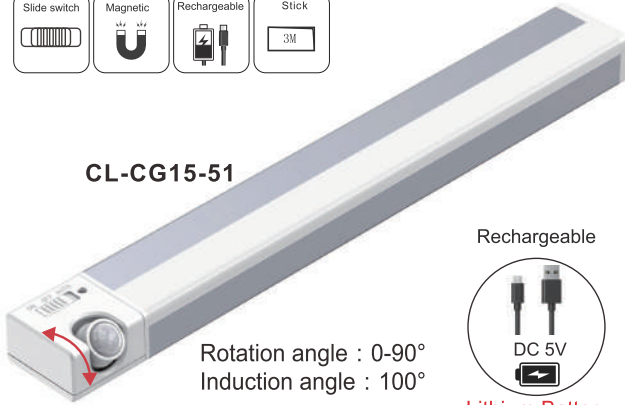

Rotation angle : 0-90°  
Induction angle : 100°



Lithium Battery

Rotation angle : 0-90°  
Induction angle : 100°

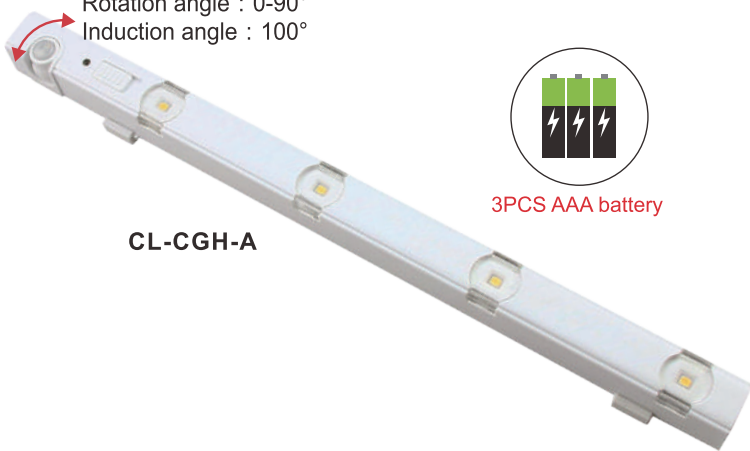

**CL-CGH-A**

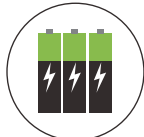

3PCS AAA battery



| Model:              | CL-CG15-51      | CL-CGH-A       |
|---------------------|-----------------|----------------|
| Power Supply:       | 3.7V 1800mAh    | 3*AAA          |
| Power(W):           | 2.5             | 0.3            |
| Body Material:      | ABS+PC+Aluminum | ABS+PC         |
| Led Type:           | 2835            | 2835           |
| Led Qty(pcs):       | 24              | 4              |
| Luminous Flux(lm):  | 200 ± 10%       | 30 ± 5%        |
| CRI(Ra):            | >80             | >80            |
| CCT(K):             | 3000/4000/6000  | 3000/4000/6000 |
| Sensor Distance(m): | 2-5             | 2-5            |
| Product Size(mm):   | 300*37.5*22     | 290*19*22      |
| Sensor Mode:        | PIR sensor      | PIR sensor     |
| Delay Time:         | 30s             | 30s            |
| Switch Mode:        | ON/OFF/AUTO     | ON/OFF/AUTO    |
| Charging Time(h):   | 3~3.5           | /              |
| Working Time(h):    | ≥3              | ≥4.7           |



| Model:              | CL-CGG-A       | CL-CGG-F       | CL-CGL-A       |
|---------------------|----------------|----------------|----------------|
| Power Supply:       | 3*AA           | 3*AA           | 3*AAA          |
| Power(W):           | 1.5            | 1.5            | 0.5            |
| Body Material:      | ABS            | ABS            | ABS            |
| Led Type:           | 2835           | 2835           | 2835           |
| Led Qty(pcs):       | 6              | 6              | 6              |
| Luminous Flux(lm):  | 85±5%          | 85±5%          | 50±5%          |
| CRI(Ra):            | >80            | >80            | >80            |
| CCT(K):             | 3000/4000/6000 | 3000/4000/6000 | 3000/4000/6000 |
| Sensor Distance(m): | 2-5            | 2-5            | 2-5            |
| Product Size(mm):   | 280*44.5*22    | 280*44.5*22    | 180*30*24.5    |
| Sensor Mode:        | Switch button  | PIR sensor     | PIR sensor     |
| Delay Time:         | /              | 30s            | 30s            |
| Switch Mode:        | 20%50%100%     | /              | /              |
| Working Time(h):    | ≥7             | ≥7             | ≥2.5           |



**CL-CG13-51**  
PIR Sensor

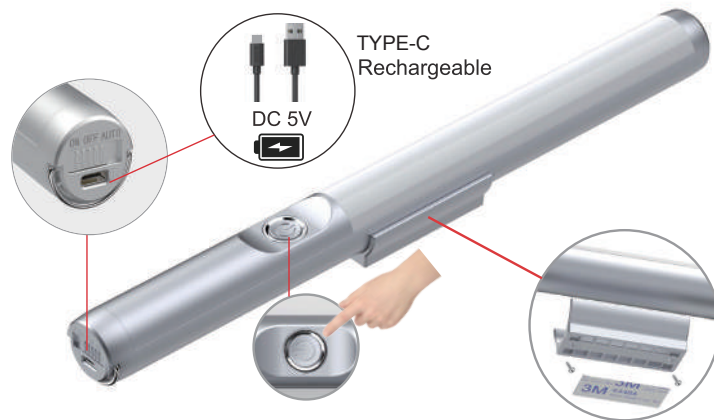

**CL-CG13-11**  
Press Down



This product is widely used for cabinet, wardrobe, wine cabinet and other places. Make your life more intelligent and enjoyable.

| Model:              | CL-CG13-51      | CL-CG13-11      |
|---------------------|-----------------|-----------------|
| Power Supply:       | 3.7V 1800mAh    | 3.7V 1800mAh    |
| Power(W):           | 2.5             | 2.5             |
| Body Material:      | Aluminum+ABS+PC | Aluminum+ABS+PC |
| Led Type:           | 2835            | 2835            |
| Led Qty(pcs):       | 30              | 30              |
| Luminous Flux(lm):  | 200 ± 10%       | 200 ± 10%       |
| CRI(Ra):            | >80             | >80             |
| CCT(K):             | 3000/4000/6000  | 3000/4000/6000  |
| Sensor Distance(m): | 2-5             | /               |
| Product Size(mm):   | Φ28*310         | Φ28*310         |
| Sensor Mode:        | PIR sensor      | Button Switch   |
| Delay Time:         | 30s             | /               |
| Switch Mode:        | ON/OFF/AUTO     | 25%/50%/100%    |
| Charging Time(h):   | 3~3.5           | 3~3.5           |
| Working Time(h):    | ≥3              | ≥3              |

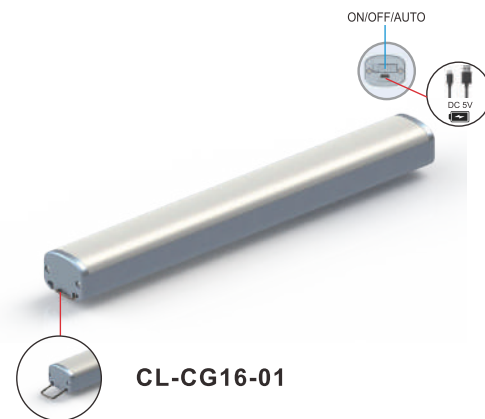
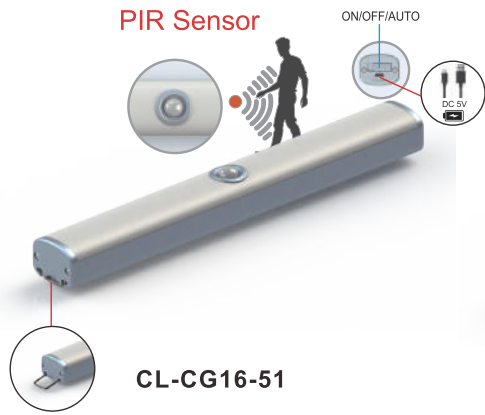

This product is widely used for cabinet, wardrobe, wine cabinet and other places. Make your life more intelligent and enjoyable.

| Model:              | CL-CG16-51      | CL-CG16-11      | CL-CG16-01      | CL-CG23-51     |
|---------------------|-----------------|-----------------|-----------------|----------------|
| Power Supply:       | 3.7V 3000mAh    | 3.7V 3000mAh    | 3.7V 3000mAh    | 3.7V 1000mAh   |
| Power(W):           | 4               | 4               | 4               | 0.8            |
| Body Material:      | ABS+PC+Aluminum | ABS+PC+Aluminum | ABS+PC+Aluminum | AL+PL          |
| Led Type:           | 2835            | 2835            | 2835            | 2835           |
| Led Qty(pcs):       | 46              | 46              | 46              | 16             |
| Luminous Flux(lm):  | 280 ± 10%       | 280 ± 10%       | 280 ± 10%       | 80 ± 5%        |
| CRI(Ra):            | >80             | >80             | >80             | >80            |
| CCT(K):             | 3000/4000/6000  | 3000/4000/6000  | 3000/4000/6000  | 3000/4000/6000 |
| Sensor Distance(m): | 2-5             | 2-5             | 2-5             | 2-5            |
| Product Size(mm):   | 280*36*28       | 280*36*28       | 280*36*28       | 200*26*22      |
| Sensor Mode:        | PIR sensor      | Button Switch   | Button Switch   | PIR sensor     |
| Delay Time:         | 30s             | /               | /               | /              |
| Switch Mode:        | ON/OFF/AUTO     | 20% 50% 100%    | OFF 50% 100%    | AUTO/OFF/ON    |
| Charging Time(h):   | 5~8             | 5~8             | 5~8             | 2~3            |
| Working Time(h):    | ≥3.5            | ≥3.5            | ≥3.5            | ≥4.5           |



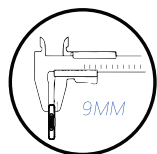

PIR Sensor



CL-CG17



ON/OFF/AUTO

PIR Sensor

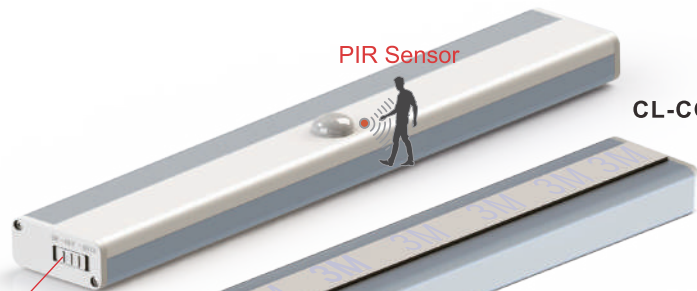

CL-CG20-51

ON/OFF/AUTO



PIR Sensor



CL-CG24-51



Button Switch

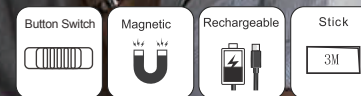
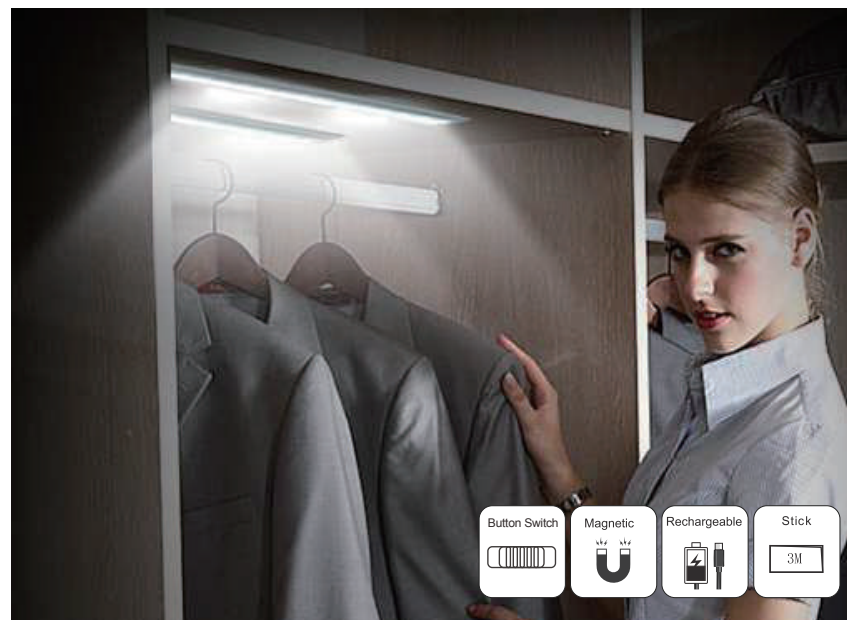

This product is widely used for cabinet, wardrobe, wine cabinet and other places. Make your life more intelligent and enjoyable.

| Model:              | CL-CG17-51      | CL-CG17-52      | CL-CG20-51     | CL-CG24-51      |
|---------------------|-----------------|-----------------|----------------|-----------------|
| Power Supply:       | 3.7V 1100mAh    | 3.7V 2200mAh    | 3.7V 1800mAh   | 3.7V 2000mAh    |
| Power(W):           | 1.5             | 2.5             | 2.5            | 2.5             |
| Body Material:      | Aluminum+PC+ABS | Aluminum+PC+ABS | ABS+PC         | Aluminum+PC+ABS |
| Led Type:           | 4014            | 4014            | 2835           | 2835            |
| Led Qty(pcs):       | 48              | 86              | 60             | 110             |
| Luminous Flux(lm):  | 85 ± 5%         | 150 ± 10%       | 200 ± 10%      | 260 ± 10%       |
| CRI(Ra):            | >80             | >80             | >80            | >80             |
| CCT(K):             | 3000/4000/6000  | 3000/4000/6000  | 3000/4000/6000 | 3000/4000/6000  |
| Sensor Distance(m): | 2~5             | 2~5             | 2~5            | 2~5             |
| Product Size(mm):   | 300*40*9        | 500*40*9        | 300*48*22      | 405*40*17       |
| Sensor Mode:        | PIR sensor      | PIR sensor      | PIR sensor     | PIR sensor      |
| Delay Time:         | 30s             | 30s             | 30s            | 30s             |
| Switch Mode:        | ON/OFF/AUTO     | ON/OFF/AUTO     | ON/OFF/AUTO    | ON/OFF/AUTO     |
| Charging Time(h):   | 1~2             | 3~4             | 2~3            | 2~3             |
| Working Time(h):    | ≥2.5            | ≥2.5            | ≥2.5           | ≥2.5            |

**NEW**



**CL-CG27**

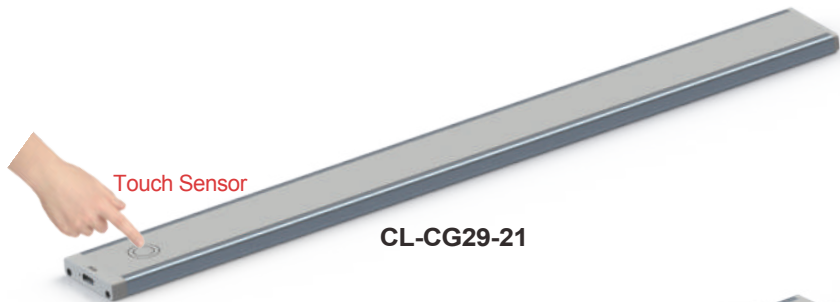

**CL-CG29-21**

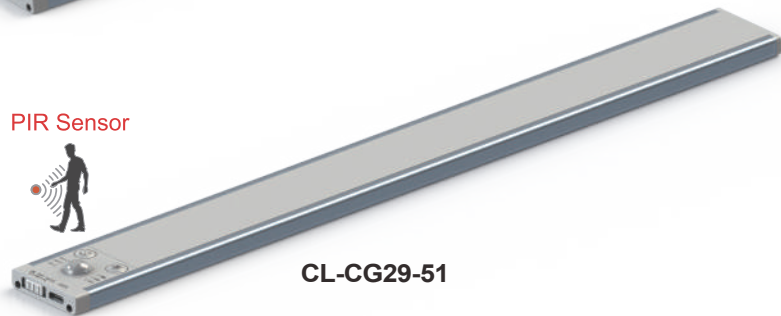

**CL-CG29-51**



| Model:              | CL-CG27           | CL-CG29-21(40cm)    | CL-CG29-51(40cm)    |
|---------------------|-------------------|---------------------|---------------------|
| Power Supply:       | 3.7V 2000mAh      | Polymer/3.7V/2200mA | Polymer/3.7V/2200mA |
| Power(W):           | 2.2               | 2.5                 | 2.5                 |
| Body Material:      | ABS+PC+6063AL     | AL+ABS+PC           | AL+ABS+PC           |
| Led Type:           | 2835              | 4014                | 4014                |
| Led Qty(pcs):       | 78                | 150                 | 138                 |
| Luminous Flux(lm):  | 125Lm±10%         | 100Lm±10%           | 100Lm±10%           |
| CRI(Ra):            | >80               | >80                 | >80                 |
| CCT(K):             | 3000K/4000K/6000K | 3000K/4000K/5000K   | 3000K/4000K/5000K   |
| Sensor Distance(m): | 2~5               | /                   | 2~5                 |
| Product Size(mm):   | 400*41*16.5       | 400*41.2*9.2        | 400*41.2*9.2        |
| Sensor Mode:        | PIR sensor        | Touch sensor        | PIR sensor          |
| Delay Time:         | 30s               | /                   | 15S/30S/90S         |
| Switch Mode:        | ON/OFF/CCT        | ON/OFF/CCT          | AUTO/OFF/ON         |
| Charging Time(h):   | 1~2               | 3~4                 | 3~4                 |
| Working Time(h):    | ≥2.5              | ≥3                  | ≥3                  |

**NEW**



**CL-CG28-21**



**CL-CG28-22**

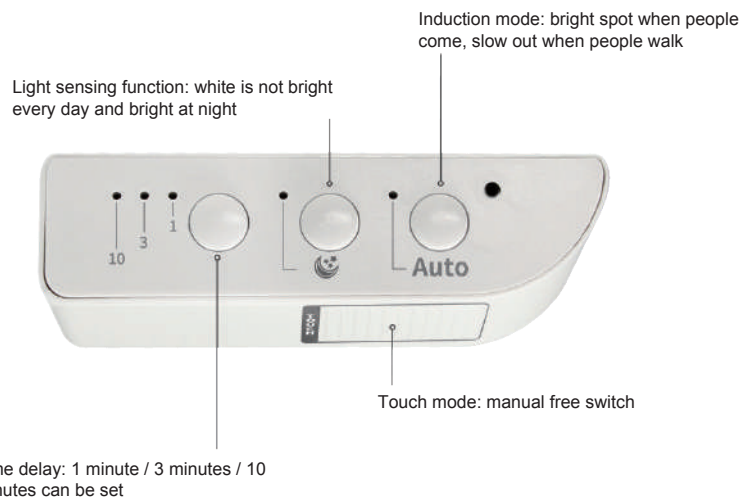

| Model:            | CL-CG28-21               | CL-CG28-22        |
|-------------------|--------------------------|-------------------|
| Voltage:          | 220V                     | 220V              |
| Power(W):         | 9                        | 11                |
| Body Material:    | PC+AL                    | PC+AL             |
| Led Type:         | 2835                     | 2835              |
| Led Qty(pcs):     | 96                       | 96                |
| Brightness:       | 560 lux(max)             | 640 lux(max)      |
| CRI(Ra):          | >80                      | >80               |
| CCT(K):           | 3000K/4000K/6000K        | 3000K/4000K/6000K |
| Sensing Distance: | 3~5                      | /                 |
| Product Size(mm): | 616*61.5*16              | 616*61.5*16       |
| Sensor Mode:      | PIR Sensor /Touch Sensor | /                 |



Hand wave sensor

CL-CG18-31

CL-CG18-01

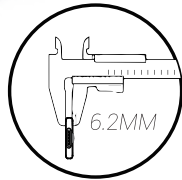
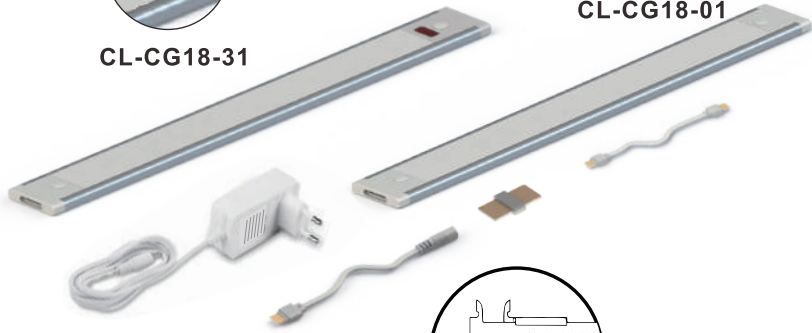

Hand wave sensor

CL-CG19-31



(AC220V)



This product is widely used for cabinet, wardrobe, wine cabinet and other places. Make your life more intelligent and enjoyable.

| Model:             | CL-CG18-31     | CL-CG18-01     | CL-CG19-31     |
|--------------------|----------------|----------------|----------------|
| Voltage:           | DC12V          | DC12V          | AC220V /50Hz   |
| Power(W):          | 3              | 3              | 9              |
| Body Material:     | Aluminum+PC    | Aluminum+PC    | ABS+PC         |
| Led Type:          | 4014           | 4014           | 2835           |
| Led Qty(pcs):      | 54             | 54             | 80             |
| Luminous Flux(lm): | 135±10%        | 140±10%        | 560±10%        |
| CRI(Ra):           | >80            | >80            | >80            |
| CCT(K):            | 3000/4000/6000 | 3000/4000/6000 | 3000/4000/6000 |
| Dimming Range:     | 8% ~ 100%      | 8% ~ 100%      | 8% ~ 100%      |
| Product Size(mm):  | 300*35*6.2     | 300*35*6.2     | 600*35*16      |





### CL-CGK-A

Dimming range: 20%, 50%, 100%  
CCT changeable 3000K to 6000K

### CL-CGK-B

Dimming range from 8% to 100%



This product is widely used for cabinet, wardrobe, wine cabinet and other places. Make your life more intelligent and enjoyable.

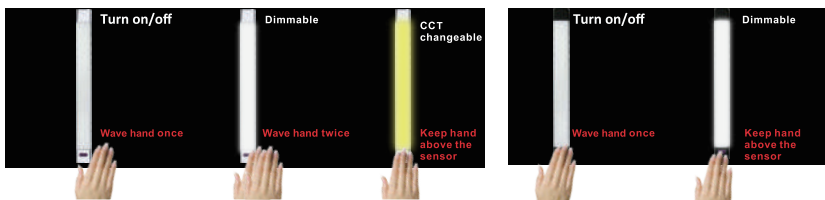

| Model:             | CL-CGK-A-5W-300 | CL-CGK-A-8W-500 | CL-CGK-B-5W-300 | CL-CGK-B-8W-500 |
|--------------------|-----------------|-----------------|-----------------|-----------------|
| Voltage:           | DC12V           | DC12V           | DC12V           | DC12V           |
| Power(W):          | 5               | 8               | 5               | 8               |
| Body Material:     | Aluminum+PC     | Aluminum+PC     | Aluminum+PC     | Aluminum+PC     |
| Led Type:          | 2835            | 2835            | 2835            | 2835            |
| Led Qty(pcs):      | 54              | 96              | 30              | 54              |
| Luminous Flux(lm): | 350±10%         | 560±10%         | 350±10%         | 560±10%         |
| CRI(Ra):           | >80             | >80             | >80             | >80             |
| CCT(K):            | 3000-6000       | 3000-6000       | 3000/4000/6000  | 3000/4000/6000  |
| Dimming Range:     | 20% 50% 100%    | 20% 50% 100%    | 8% ~ 100%       | 8% ~ 100%       |
| Product Size(mm):  | 300*30*11.5     | 500*30*11.5     | 300*30*11.5     | 500*30*11.5     |

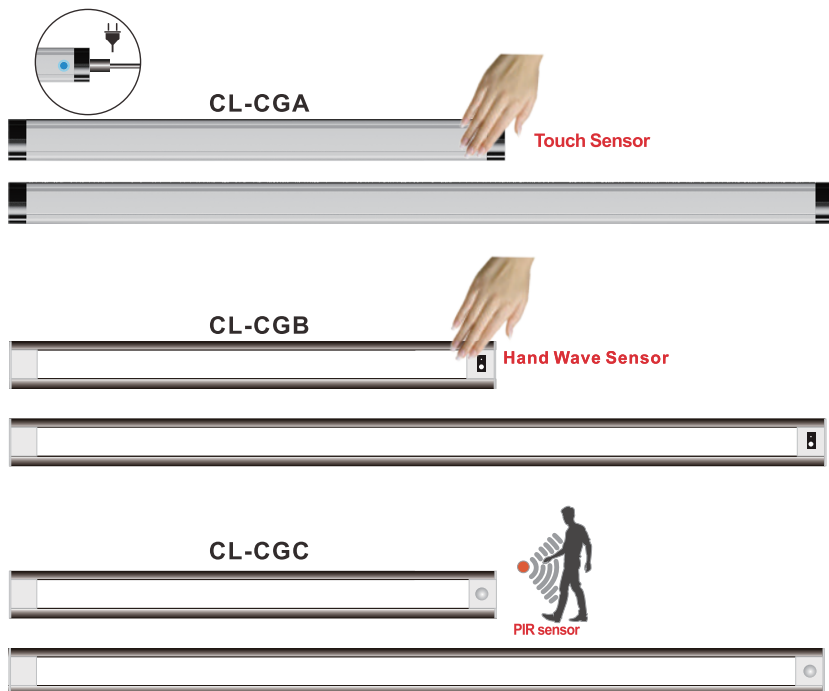

This product is widely used for cabinet, wardrobe, wine cabinet and other places. Make your life more intelligent and enjoyable.



| Model:             | CL-CGA-3W-300  | CL-CGA-5W-500  | CL-CGB-5W-300    | CL-CGB-9W-600    | CL-CGC-5W-300  | CL-CGC-9W-500  |
|--------------------|----------------|----------------|------------------|------------------|----------------|----------------|
| Voltage:           | DC12V          | DC12V          | DC12V            | DC12V            | DC12V          | DC12V          |
| Power(W):          | 3              | 5              | 5                | 9                | 5              | 9              |
| Body Material:     | Aluminum+PC    | Aluminum+PC    | Aluminum+PC      | Aluminum+PC      | Aluminum+PC    | Aluminum+PC    |
| Led Type:          | 2835           | 2835           | 2835             | 2835             | 2835           | 2835           |
| Led Qty(pcs):      | 30             | 54             | 30               | 66               | 30             | 66             |
| Luminous Flux(lm): | 220 ± 10%      | 380 ± 10%      | 380 ± 10%        | 680 ± 10%        | 380 ± 10%      | 680 ± 10%      |
| CRI(Ra):           | >80            | >80            | >80              | >80              | >80            | >80            |
| CCT(K):            | 3000/4000/6000 | 3000/4000/6000 | 3000/4000/6000   | 3000/4000/6000   | 3000/4000/6000 | 3000/4000/6000 |
| Dimming Range:     | 8% ~ 100%      | 8% ~ 100%      | 8% ~ 100%        | 8% ~ 100%        | 8% ~ 100%      | 8% ~ 100%      |
| Product Size(mm):  | 300*25*9       | 500*25*9       | 300*40*10.5      | 600*40*10.5      | 300*40*10.5    | 600*40*10.5    |
| Sensor Mode:       | Touch sensor   | Touch sensor   | Hand wave sensor | Hand wave sensor | PIR sensor     | PIR sensor     |



**CL-CGE**



**CL-CGE-RGB**



| Model:             | CL-CGE         | CL-CGE-RGB |
|--------------------|----------------|------------|
| Voltage:           | DC12V          | DC12V      |
| Power(W):          | 1.5            | 3          |
| Body Material:     | PC             | PC         |
| Led Type:          | 2835           | 5050       |
| Led Qty(pcs):      | 9              | 15         |
| Luminous Flux(lm): | 120±10%        | /          |
| CRl(Ra):           | >80            | /          |
| Led Color:         | 3000/4000/6000 | RGB        |
| Dimming Range:     | /              | /          |
| Product Size(mm):  | 400*10*7       | 400*10*7   |



**CL-CGD**



**CL-CG25**



|                           |                |                |
|---------------------------|----------------|----------------|
| <b>Model:</b>             | <b>CL-CGD</b>  | <b>CL-CG25</b> |
| <b>Voltage:</b>           | DC24V          | DC12V          |
| <b>Power(W):</b>          | 6              | 8              |
| <b>Body Material:</b>     | Aluminum+PC    | ABS            |
| <b>Led Type:</b>          | 2835           | 5050           |
| <b>Led Qty(pcs):</b>      | 72             | 36(4*9)        |
| <b>Luminous Flux(lm):</b> | 500±10%        | 110±10%(W)     |
| <b>CRI(Ra):</b>           | >80            | >80            |
| <b>CCT(K):</b>            | 3000/4000/6000 | RGB            |
| <b>Product Size(mm):</b>  | 600*25.5*8     | ø57*6          |



# LED Touch Sensor Strip



|                           |                 |                  |
|---------------------------|-----------------|------------------|
| <b>Model:</b>             | <b>CL-CMA</b>   | <b>CL-SSA</b>    |
| <b>Voltage:</b>           | DC12V           | DC12V            |
| <b>Power(W/m):</b>        | 4.8             | 4.8              |
| <b>Led Type:</b>          | 2835            | 2835             |
| <b>Led Qty(LED/m):</b>    | 60              | 60               |
| <b>Luminous Flux(lm):</b> | 550 ± 10%(1.5m) | 550 ± 10%(1.5m)  |
| <b>CRI(Ra):</b>           | >80             | >80              |
| <b>CCT(K):</b>            | 3000/4000/6000  | 3000/4000/6000   |
| <b>Strips length(m):</b>  | 1 / 1.5 / 3     | 1 / 1.5 / 3      |
| <b>Sensor Mode:</b>       | Touch sensor    | Hand wave switch |

## LED Ambient Light

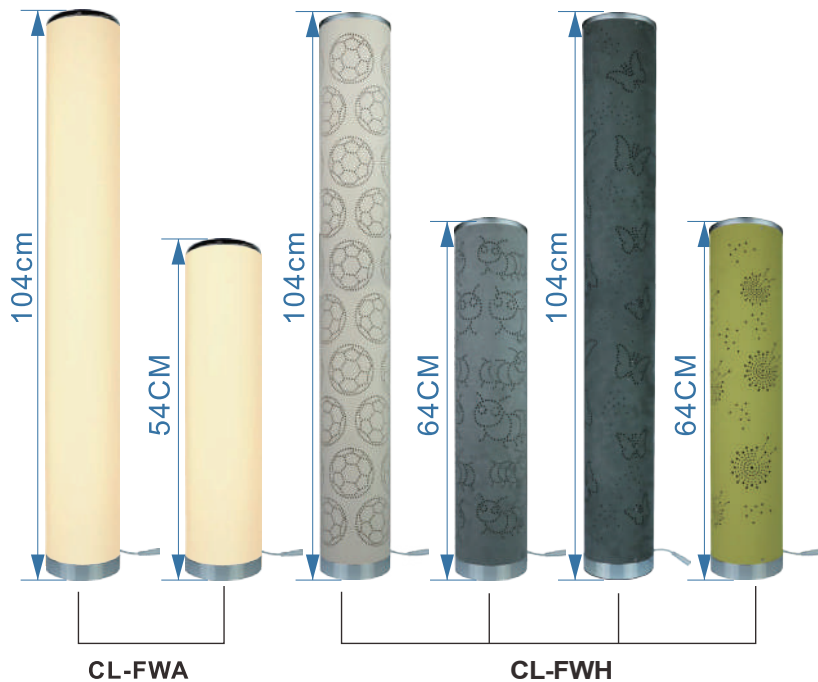

| Model:            | CL-FWA-104 | CL-FWA-54 | CL-FWH-104        | CL-FWH-64         |
|-------------------|------------|-----------|-------------------|-------------------|
| Voltage:          | DC12V      | DC12V     | DC12V             | DC12V             |
| Power(W):         | 10         | 5         | 10                | 5                 |
| Body Material:    | ABS        | ABS       | ABS               | ABS               |
| Led Type:         | 5050+2835  | 5050+2835 | 2835              | 2835              |
| Led Qty(pcs):     | 180        | 90        | 60                | 36                |
| CRI(Ra):          | >80        | >80       | >80               | >80               |
| Led Color:        | RGB+W      | RGB+W     | 3000K/4000K/6000K | 3000K/4000K/6000K |
| Product Size(mm): | Φ 129*1040 | Φ 129*540 | Φ 129*1040        | Φ 129*640         |

**NEW** LED Ambient Light → **DIY**



CL-FW01



Print what you like

CL-FW01-E



|                          |                 |                     |
|--------------------------|-----------------|---------------------|
| <b>Model:</b>            | <b>CL-FW01</b>  | <b>CL-FW01-E</b>    |
| <b>Voltage:</b>          | DC12V           | DC5V                |
| <b>Power(W):</b>         | 10              | 12                  |
| <b>Body Material:</b>    | PP+ABS          | PP+ABS              |
| <b>Led Type:</b>         | 5050RGB+2835CCT | 2835                |
| <b>Led Qty(pcs):</b>     | 120+60          | 40(3000K)+40(5000K) |
| <b>CRI(Ra):</b>          | >80             | >80                 |
| <b>Led Color:</b>        | RGB+W           | 3000K+5000K         |
| <b>Product Size(mm):</b> | ø128*1040       | ø128*1040           |

**NEW** LED Ambient Light → **DIY**

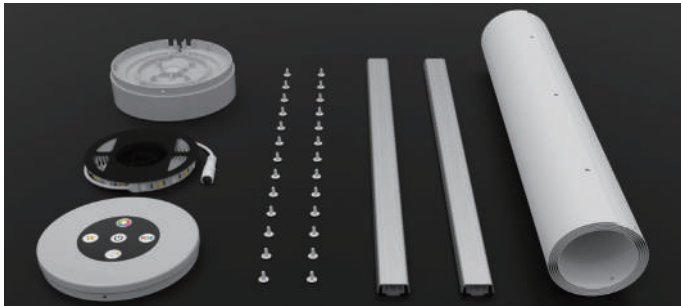

CL-FW02



| Model:            | CL-FW02-A       | CL-FW02-B       | CL-FW02-C       | CL-FW02-D       |
|-------------------|-----------------|-----------------|-----------------|-----------------|
| Voltage:          | DC12V           | DC12V           | DC5V 2A         | DC12V           |
| Power(W):         | 10              | 10              | 10              | 10x2            |
| Body Material:    | ABS             | ABS             | PP+ABS          | ABS             |
| Led Type:         | 5050RGB+2835CCT | 5050RGB+2835CCT | 5050RGB+2835CCT | 5050RGB+2835CCT |
| Led Qty(pcs):     | 60+60           | 60+60           | 60+60           | (60+60)+(60+60) |
| CRI(Ra):          | >80             | >80             | >80             | >80             |
| Led Color:        | RGB+W           | RGB+W           | RGB+W           | RGB+W           |
| Product Size(mm): | ø128*880        | ø128*880        | ø128*880        | ø128*880        |



# LED Floor Light → **DIY**

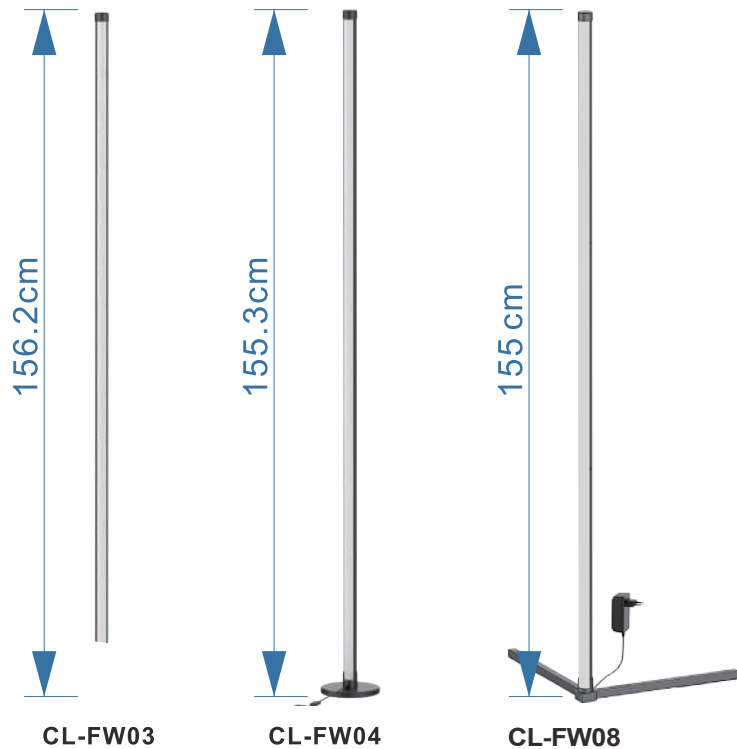

DC 12V



Easy to install



Bluetooth



Eye-Protection



Dimmable



Music Mode



Remote



Wi-Fi

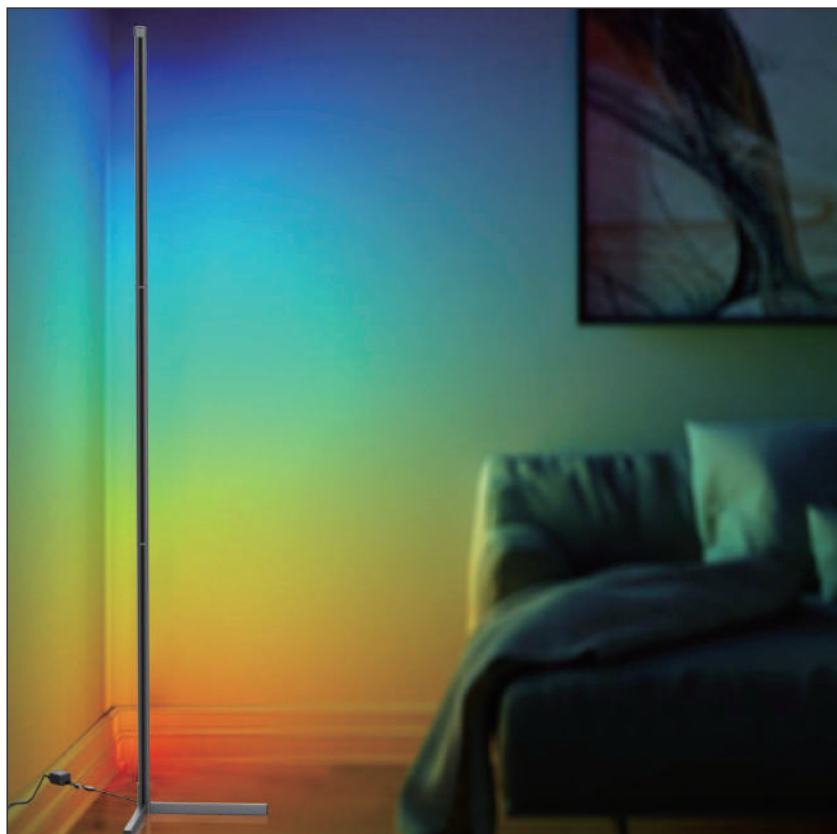

| Model:            | CL-FW03                     | CL-FW04                     | CL-FW08                     |
|-------------------|-----------------------------|-----------------------------|-----------------------------|
| Voltage:          | DC12V                       | DC12V                       | DC12V/1.5A                  |
| Power(W):         | 18                          | 18                          | 18                          |
| Body Material:    | Aluminum alloy+ABS+Silicone | Aluminum alloy+ABS+Silicone | aluminum alloy+ABS+Silicone |
| Led Type:         | 5050+2835                   | 5050+2835                   | 5050+2835                   |
| Led Qty(pcs):     | 90(5050)+90(2835)           | 90(5050)+90(2835)           | 90(5050)+90(2835)           |
| CRI(Ra):          | >80                         | >80                         | >80                         |
| Led Color:        | RGB+W                       | RGB+W                       | RGB+W                       |
| Product Size(mm): | Φ30*1562                    | Φ30*1553                    | ø30*1550                    |

# LED Floor Light → DIY

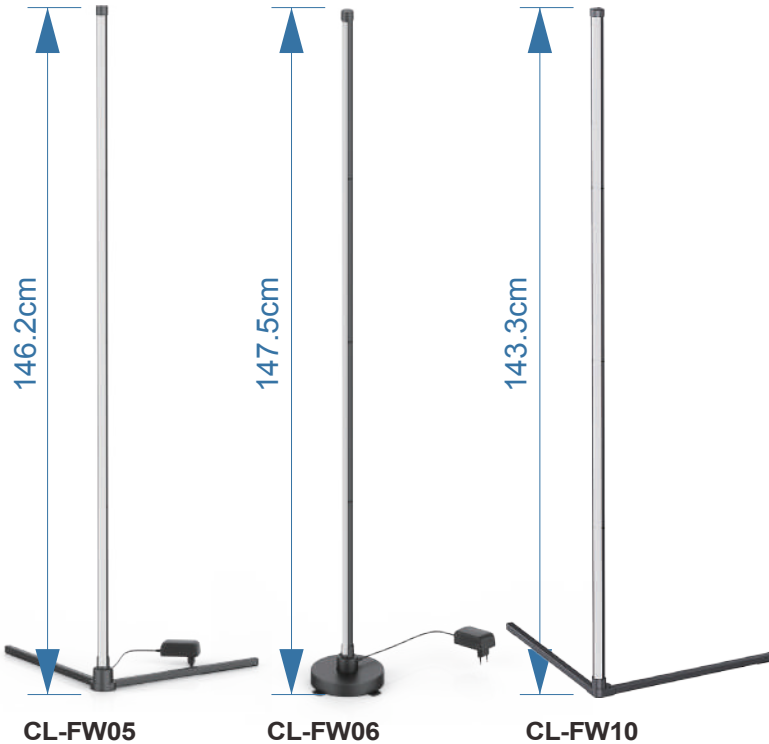

DC 12V



Easy to install



Bluetooth



Eye-Protection



Dimmable



Music Mode



Remote



Wi-Fi



| Model:            | CL-FW05                     | CL-FW06                     | CL-FW10                     |
|-------------------|-----------------------------|-----------------------------|-----------------------------|
| Voltage:          | DC12V/1.5A                  | DC12V/1.5A                  | DC 5V/2A                    |
| Power(W):         | 17                          | 17                          | 10                          |
| Body Material:    | aluminum alloy+ABS+Silicone | aluminum alloy+ABS+Silicone | aluminum alloy+ABS+Silicone |
| Led Type:         | 5050+2835                   | 5050+2835                   | 5050                        |
| Led Qty(pcs):     | 84(5050)+84(2835)           | 84(5050)+84(2835)           | 84                          |
| CRI(Ra):          | >80                         | >80                         | >80                         |
| Led Color:        | RGB+W                       | RGB+W                       | RGB                         |
| Product Size(mm): | ø23.5*1462                  | ø23.5*1475                  | 27*1433                     |

# LED Floor Light →DIY



DC 12V



Easy to install



Eye-Protection



DIMMABLE  
light



Music Mode



Remote



Wi-Fi



Bluetooth



104.5cm



CL-FW09



|                   |                             |
|-------------------|-----------------------------|
| <b>Model:</b>     | <b>CL-FW09</b>              |
| Voltage:          | DC12V/1.5A                  |
| Power(W):         | 20                          |
| Body Material:    | aluminum alloy+ABS+Silicone |
| Led Type:         | 5050+2835                   |
| Led Qty(pcs):     | 120(5050)+120(2835)         |
| CRI(Ra):          | >80                         |
| Led Color:        | RGB+W                       |
| Product Size(mm): | ø130*1045                   |

**NEW** LED Floor Light → **DIY**

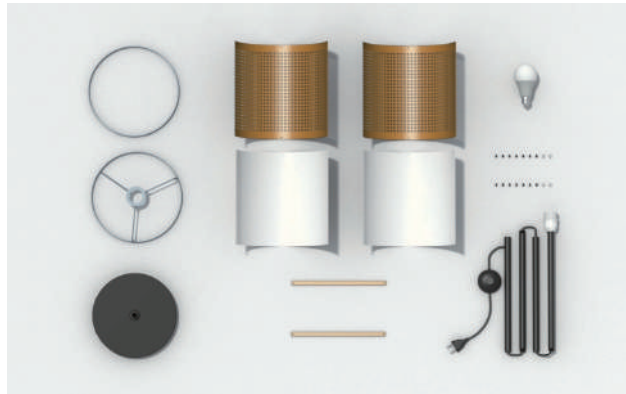

CL-FW14

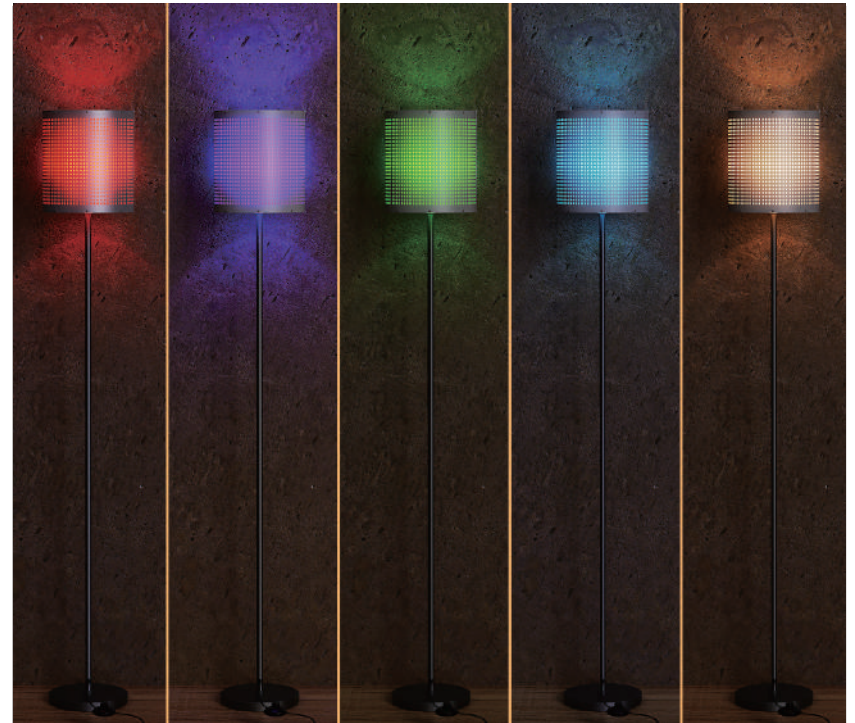

|                   |                           |
|-------------------|---------------------------|
| <b>Model:</b>     | <b>CL-FW14</b>            |
| Voltage:          | AC 110-130V / AC 220-240V |
| Power(W):         | 9                         |
| Body Material:    | High quality iron+PP      |
| Led Type:         | 5050+2835                 |
| Led Qty(pcs):     | ?                         |
| CRI(Ra):          | >80                       |
| Led Color:        | RGB+CCT                   |
| Product Size(mm): | Ø275*1680                 |



**NEW** LED Floor Light → **DIY**

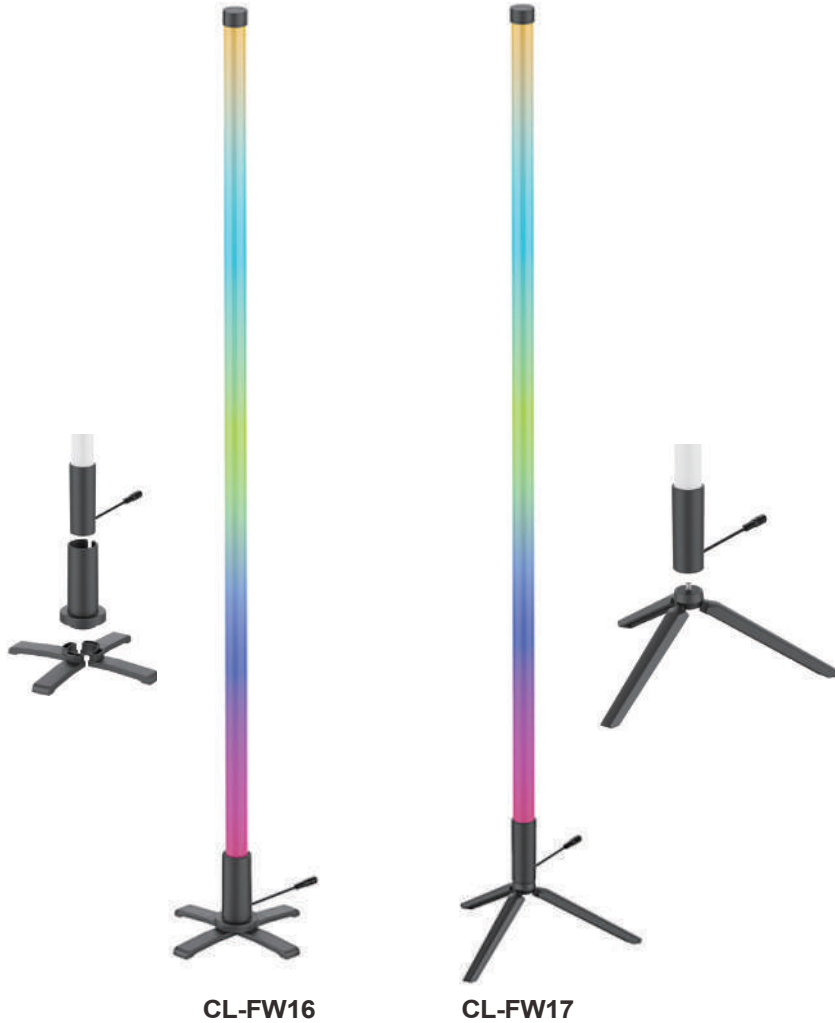

| Model:            | CL-FW16           | CL-FW17           |
|-------------------|-------------------|-------------------|
| Voltage:          | DC 12V/1A         | DC 12V/1A         |
| Power(W):         | 10                | 10                |
| Body Material:    | PC+ABS            | PC+ABS            |
| Led Type:         | 5050+2835         | 5050+2835         |
| Led Qty(pcs):     | 78+78             | 78+78             |
| CRI(Ra):          | >80               | >80               |
| Led Color:        | 3000K/4000K/6000K | 3000K/4000K/6000K |
| Product Size(mm): | Ø30*1345          | Ø30*1395          |

**NEW** LED Ambient Light → **DIY**

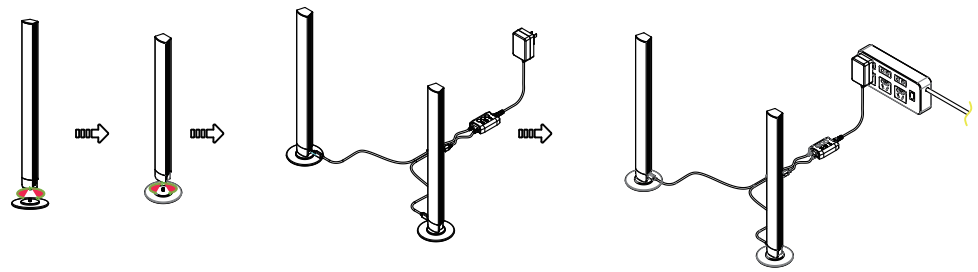

CL-FW15

|                   |             |
|-------------------|-------------|
| Model:            | CL-FW15     |
| Voltage:          | DC 5V/2A    |
| Power(W):         | 10          |
| Body Material:    | ABS+PC      |
| Led Type:         | 5050        |
| Led Qty(pcs):     | 60          |
| CRI(Ra):          | >80         |
| Led Color:        | RGB         |
| Product Size(mm): | 34.3*25*380 |



## LED Ambient Light



CL-FWE

CL-FWF



CL-FWG



| Model:            | CL-FWE         | CL-FWF                | CL-FWG         |
|-------------------|----------------|-----------------------|----------------|
| Voltage:          | DC3.7V/4400mAh | DC3.7V/4400mAh        | DC3.7V/3600mAh |
| Power(W):         | 3.5            | 1.7                   | 5              |
| Body Material:    | ABS+PC         | ABS+PC+Aluminum alloy | ABC+PC         |
| Led Type:         | 5050RGB+2835W  | 5050RGB+2835W         | 5050RGB+2835W  |
| Led Qty(pcs):     | 36+36          | 18+18                 | 25+30          |
| CRI(Ra):          | >80            | >80                   | >80            |
| Led Color:        | RGB+W          | RGB+W                 | RGB+W          |
| Product Size(mm): | ø130*ø45*376   | ø130*ø45*376          | ø110*185       |

NEW

# LED Ambient Light

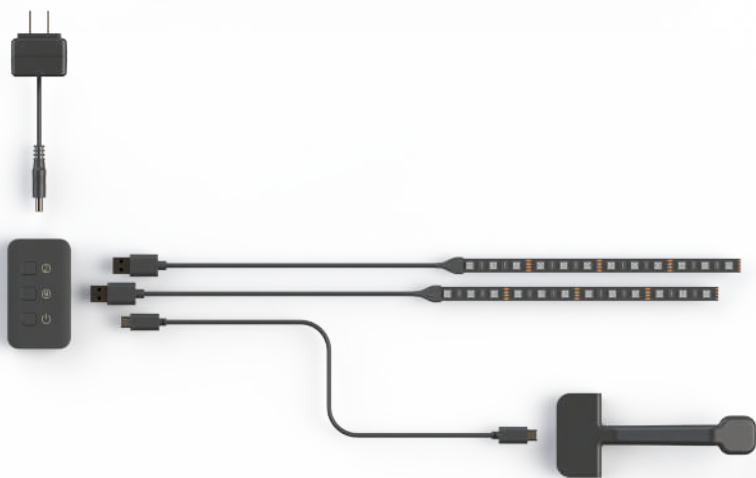

CL-TV01

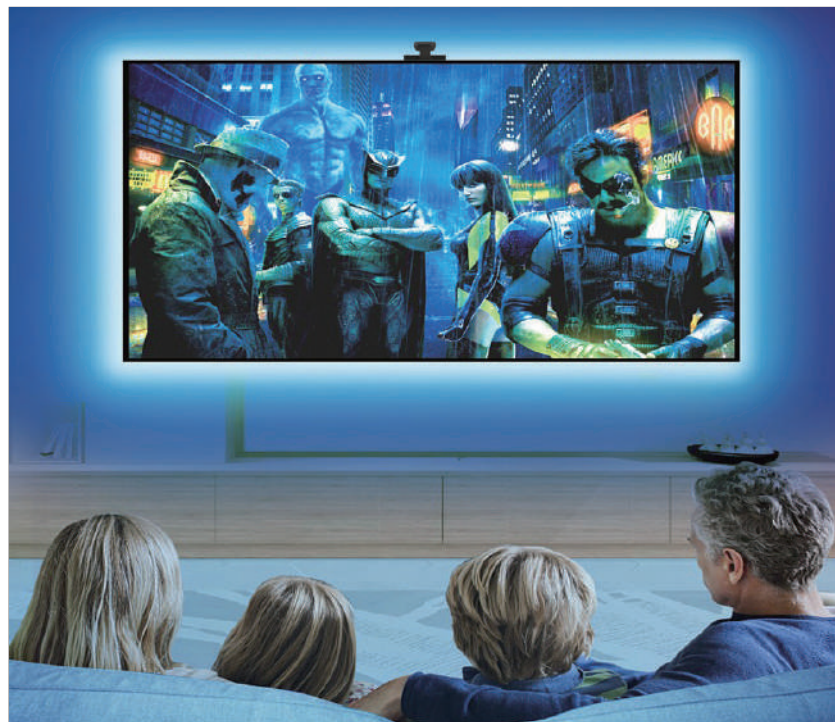

|                   |                 |
|-------------------|-----------------|
| Model:            | CL-TV01         |
| Voltage:          | DC5V            |
| Power(W):         | 5W              |
| Body Material:    | ABS             |
| Led Type:         | 5050            |
| Led Qty(pcs):     | 135             |
| CRI(Ra):          | /               |
| Led Color:        | RGB             |
| Product Size(mm): | 4500(LED Strip) |



# LED Camping Lamp



**CL-YDB**



**CL-YDC**



**CL-CTD-A**



**CL-JZD-B**



| Model:             | CL-YDB         | CL-YDC         | CL-CTD-A             | CL-JZD-B             |
|--------------------|----------------|----------------|----------------------|----------------------|
| Power Supply:      | 3.2V 5000mAh   | 3.7V 4400mAh   | AC 230V              | AC 230V              |
| Power(W):          | 5              | 5              | 3.5                  | 3.5                  |
| Body Material:     | ABS+PC         | ABS+PC         | ABS+PC+ Carbon steel | ABS+PC+ Carbon steel |
| Led Type:          | 2835           | 2835           | 2835                 | 2835                 |
| Led Qty(pcs):      | 30             | 30             | 15                   | 15                   |
| Luminous Flux(lm): | 500±10%        | 500±10%        | 250±10%              | 250±10%              |
| CRI(Ra):           | >80            | >80            | >80                  | >80                  |
| CCT(K):            | 3000/4000/6000 | 3000/4000/6000 | 3000/4000/6000       | 3000/4000/6000       |
| Product Size(mm):  | 80*80*180      | 80*80*250      | Ø80*392              | Ø80*375              |
| Sensor Mode:       | Button Switch  | Button Switch  | Rotary Switches      | Rocker switch        |
| Switch Mode:       | 25%50%100%     | 25%50%100%     | OFF/ON               | OFF/ONFF             |
| Charging Time(h):  | 5~6            | 4~5            | /                    | /                    |
| Working Time(h):   | ≥4             | ≥4             | /                    | /                    |

# Solar Intelligent Sensor Light



It is automatically charged during the day.

**CL-TYH**



**CL-TYB**



PIR sensor



**CL-TYF**



PIR sensor



| Model:              | CL-TYH-3W      | CL-TYB-2W      | CL-TYB-3W      | CL-TYF         |
|---------------------|----------------|----------------|----------------|----------------|
| Power Supply:       | 3.7V 1500mAh   | 3.7V 1500mAh   | 3.7V 1500mAh   | 3.7V 1200mAh   |
| Power(W):           | 3              | 2              | 3              | 0.55           |
| Body Material:      | ABS            | ABS            | ABS            | ABS            |
| Led Type:           | 2835           | 2835           | 2835           | 2835           |
| Led Qty(pcs):       | 24             | 10             | 14             | 20             |
| Luminous Flux(lm):  | 300 ± 10%      | 120 ± 10%      | 250 ± 10%      | 100 ± 10%      |
| CRI(Ra):            | >80            | >80            | >80            | >80            |
| CCT(K):             | 3000/4000/6000 | 3000/4000/6000 | 3000/4000/6000 | 3000/4000/6000 |
| Product Size(mm):   | 97*46*123      | 100*138*69     | 100*138*69     | 95*125*50      |
| Sensor Mode:        | PIR Sensor     | PIR Sensor     | PIR Sensor     | PIR Sensor     |
| Sensor Distance(m): | 4-6            | 4-6            | 4-6            | 4-6            |
| Delay Time:         | 30s            | 30s            | 30s            | 30s            |
| Switch Mode:        | ON/OFF         | ON/OFF         | ON/OFF         | ON/OFF         |
| Charging Time(h):   | 4              | 4              | 4              | 4              |
| Working Time(h):    | ≥2.6           | ≥2.6           | ≥2.6           | ≥2.6           |
| IP Rating:          | IP 65          | IP 65          | IP 65          | IP 65          |

# LED Solar Ground Light

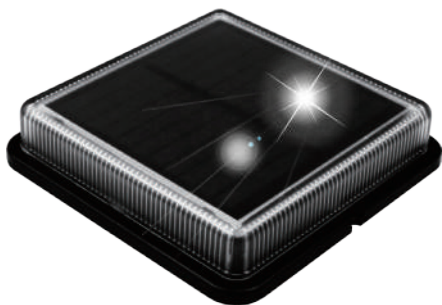

**CL-DDA**



4

5.5v 0.88w Solar Panel  
4 Hours Charge 100%  
3.7V 700/800mAh Battery



16

Light Sensor Switch  
Auto Turn On Light 20lm  
1-2 Nights



Safety and energy saving

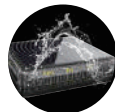

Waterproof outdoor

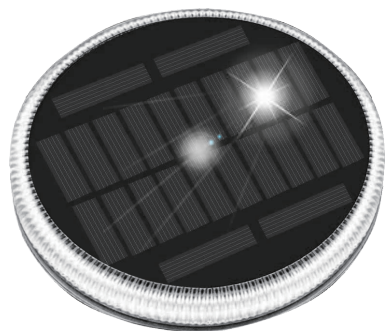

**CL-DDB**



This solar light will be on automatically at night, which is very smart and sensitive

FC CE RoHS

| Model:             | CL-DDA                    | CL-DDB                    |
|--------------------|---------------------------|---------------------------|
| Power Supply:      | 3.2V 500mAh / 3.7V 800mAh | 3.2V 500mAh / 3.7V 800mAh |
| Power(W):          | 0.4                       | 0.4                       |
| Body Material:     | ABS+PC                    | ABS+PC                    |
| Led Type:          | 2835                      | 2835                      |
| Led Qty(pcs):      | 12                        | 24                        |
| Luminous Flux(lm): | 15 ± 5%                   | 15 ± 5%                   |
| CRI(Ra):           | >80                       | >80                       |
| CCT(K):            | 3000/4000/6000            | 3000/4000/6000            |
| Product Size(mm):  | 110*110*22                | Φ 109*22                  |
| Sensor Mode:       | Lighting Sensor           | Lighting Sensor           |
| Switch Mode:       | NO                        | NO                        |
| Charging Time(h):  | 4                         | 4                         |
| Working Time(h):   | 16                        | 16                        |
| IP Rating:         | IP 67                     | IP 67                     |



## Combination Touch Lamp (DIY)



CL-MKD-C

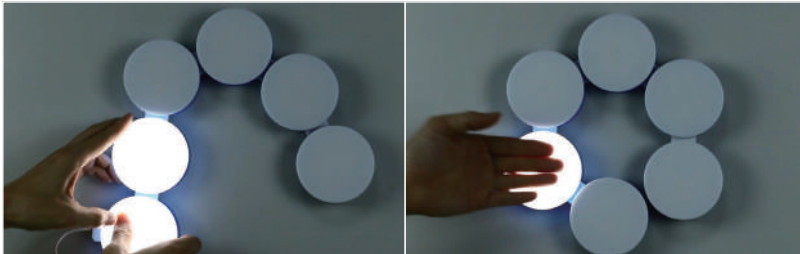

1. The conductive suction bridge is placed on the concave metal position of the product and on the place that the next production touch lamp wants to place.
2. Put another touch lamp on the conductive suction bridge, the other touch lamp and so on.
3. Random combination. Suck the other input head at the concave metal of any touch lamp and turn on the power supply.
4. Touch the sensing area lightly, the lamp will turn on, touch the lamp again and then it will go out.



A combination of lights that can be deformed, think about what you think, more interesting!



**Magnetic suction**



**Random combination**



**Touch sensor**



**Noctilucous**

|                   |                      |
|-------------------|----------------------|
| <b>Model:</b>     | <b>CL-MKD-C</b>      |
| Voltage:          | DC 12V               |
| Power(W):         | 1                    |
| Body Material:    | ABS+PC               |
| Led Type:         | 2835                 |
| Led Qty(pcs):     | 48                   |
| CCT(K):           | 3000/4000/6000/R/G/B |
| Product Size(mm): | Φ82.5*20             |
| Sensor Mode:      | Touch sensor         |
| IP Rating:        | IP 20                |



## LED Connected Lamp (DIY)

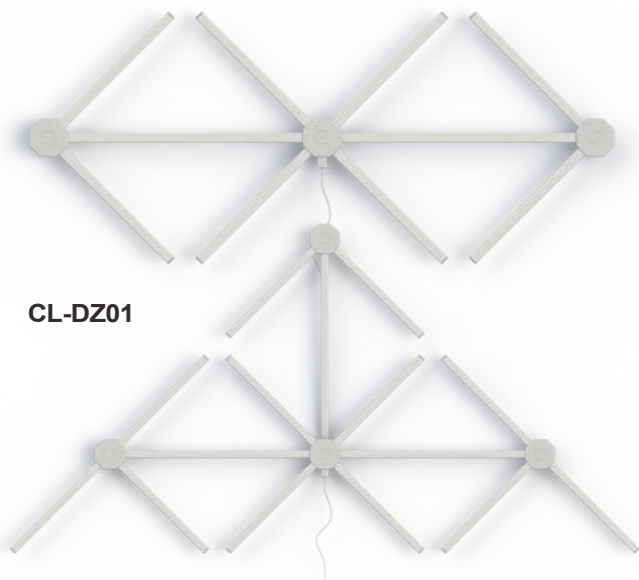

CL-DZ01

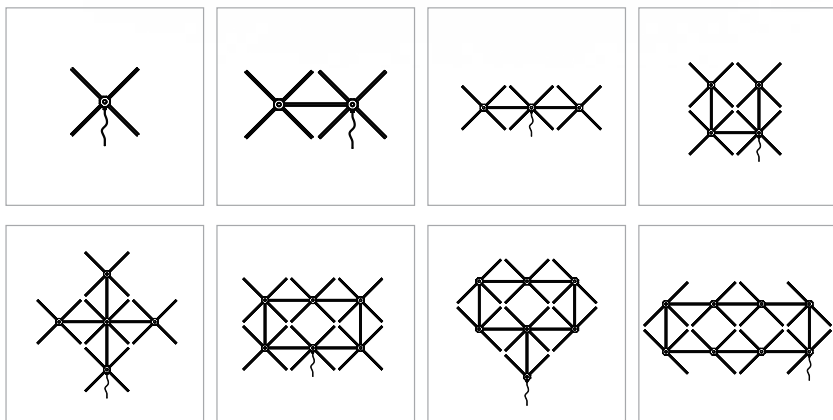

|                   |                       |
|-------------------|-----------------------|
| <b>Model:</b>     | <b>CL-DZ01</b>        |
| Voltage:          | DC12V/24V             |
| Power(W):         | 16                    |
| Body Material:    | aluminum alloy+ABS+PC |
| Led Type:         | 5050+2835             |
| Led Qty(pcs):     | 120(5050)+120(2835)   |
| CRI(Ra):          | >80                   |
| Led Color:        | RGB+W                 |
| Product Size(mm): | ø130*1045             |