



The light of the milky way



Moon ring



Flourishing age peony



Star light--front mounting



The ring



Xiangyun



The light of city



Xiangyun lawn lamp



Flourishing age peony lawn lamp



Star light lawn lamp



Moon ring lawn lamp



The light of city--hoisting



Intelligent moon garden lamp lighting system

Intelligent peony garden lamp lighting system

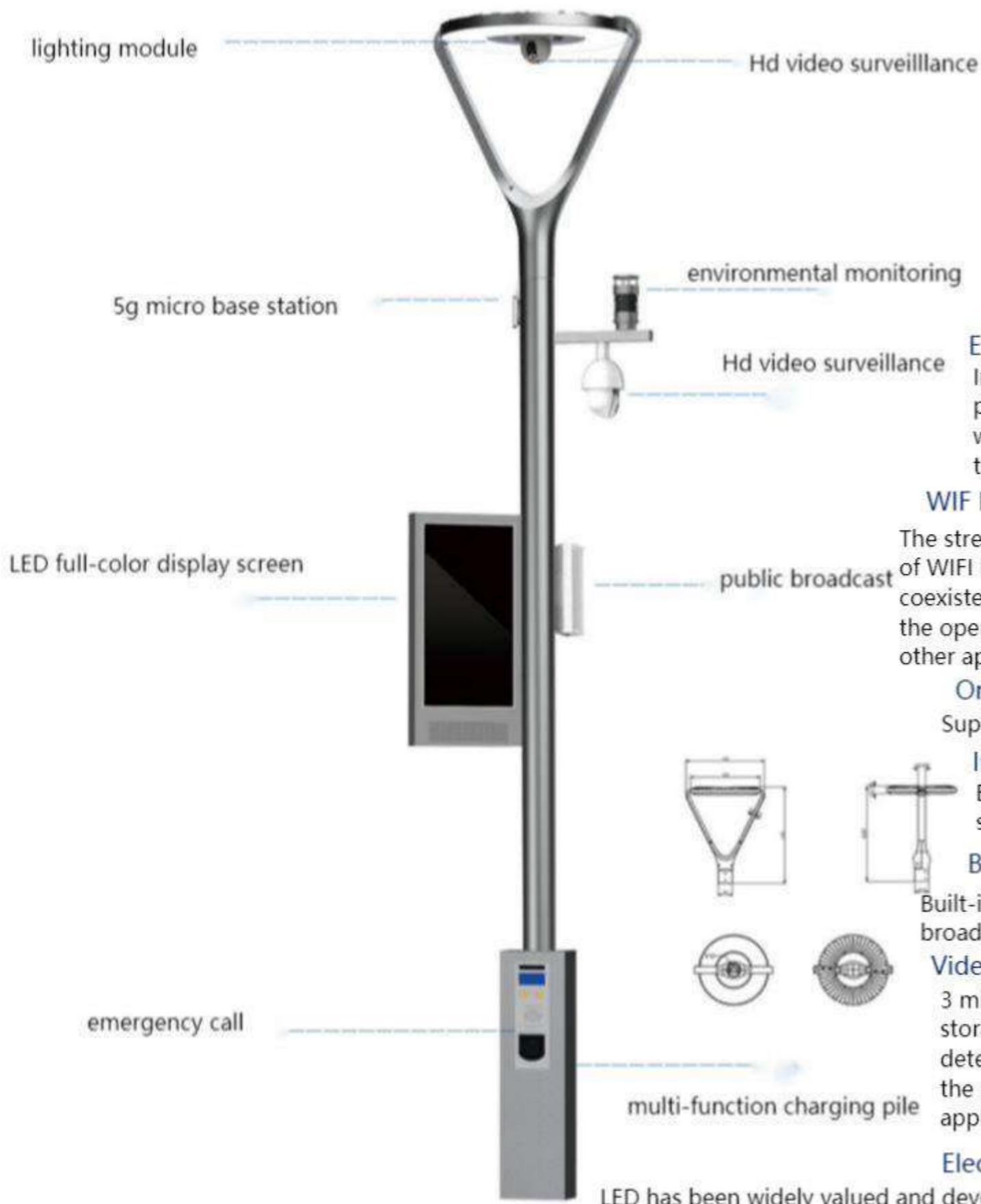

5g micro module

The pole can be reserved for moile, unicom, telecom, tower communication base station as relay coverage.

Sensor extension

Extended access: infrared sensor, radar, traffic monitoring sensor, RFID communication.

Intelligent lighting control

Realize intelligent control of lamps, dimming, switching, voltage, current, power, electricity statistics, ault warning, energy consumption analysis, GIS map, stategy control, loop monitoring, etc.

Enviromental monitoring

Intelligent street light are equipped with a variety of sound sensors, air pollution detector temperature sensor, brightness sensor, etc., used for wind direction, wind speed, temperature, rainfall, water level, and noise to achieve intelligent detection of the urban environment and weather.

WIF hotspot

The street lamp is embedded with WIFI base station to achieve the coverage of WIFI hotspots in the whole area, dual-frequency communication 2.4G/5G coexistence, well development access to 200 points, the distance of 70M, support the operation system, can be extended probe application, traffic statistics and other applications.

One-touch calling

Support one-touch calling can directly talk to monitoring room.

Intelligent charging pile

Built-in lamp pole, international interface, support platform statistics management, support APP self-charge, support process managment, operation level, monthly settlement.

Broadcast system

Built-in 30W waterproof sound column, support background music, support emergency broadcasting, support timing and monitoring room microphone polling and dialogue.

Video surveillance

3 million HD ball machine, support 360 degree rotation, support 1080P HD, support local storage, support SMART detection: area intrusion detection, boundary detection, audio abnormal detection, mobile detection, video acclusion detection function, support NVR, support access to the public security network, support video data later analysis (depending on the actual industry application) support remote view.

Electronic advertising screen

LED has been widely valued and developed rapidly, is inseparable from its own advantage. These advantages are summarized as: high brightness, low operating voltage, low power consumption, miniaturization, long life, impact resistance and stable performance. The development prospect of LED is very broad, and it is developing towards higher brightness, higher weather resistance, higher luminous density, higher luminous uniformity, reliability and panchromatic direction.

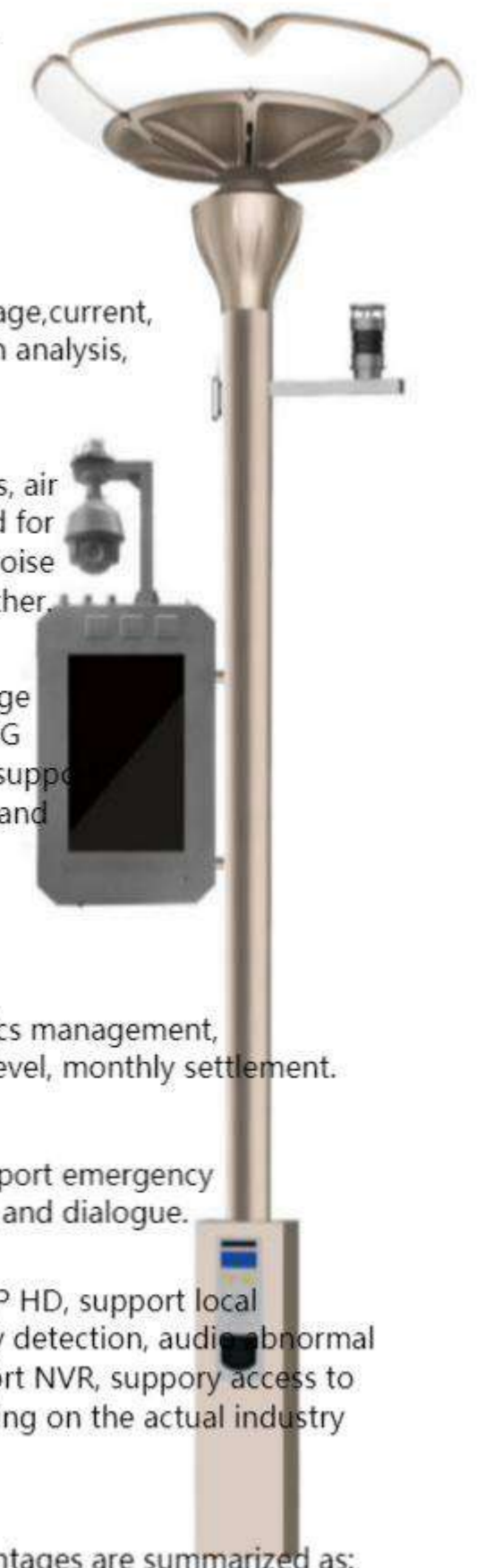

Product characteristics

Cast off inertia thinking, gift ordinary thing with unique expression form, regard lamps and lanterns as the change switch of dimensional atmosphere

Modelling atmospheric plain, the night lights up like a bright moon, so it is the light of the the moon

Material aelection of high strength die-cast aluminun alloy shell, the light itself smooth lines seamless, elegant and charming.



Moon Ring

Protection Grade	IP65
Rated Power	30-100W
Input Voltage	110-220vAc
Lifespan	50000hrs



Moon ring



Product characteristics
In the 21st century, standing at the peak of science and technology,
looking across the vast galaxy, the stars are scattered, and the
ring lamp is the brightest star in the galaxy.

Overall Dimensions



outer diameter: 89
inner diameter: 76

white cover/module style

THE RING

Protection Grade	IP65
Rated Power	50W
Input Voltage	110-220vAc
Lifespan	50000hrs



The ring



Product characteristics

In the 21st century, standing at the peak of science and technology, looking across the vast galaxy, the stars are scattered, and the light of the milky way lamp is the brightest star in the galaxy.

Overall Dimensions



Utility model/solar model

THE LIGHT OF THE MILKY WAY

Protection Grade	IP65
Rated Power	30-60W
Input Voltage	110-220vAc
Lifespan	50000hrs



The light of the milky way

Product characteristics

Garden lighting.XiangYun.

This is the most beautiful cloud under the blue sky, the beautiful scenery around you during the day, and the brightest lamp in front of you at night. The luminaire modeling elements are charming, the luminous surface is the light source is also the design point, like the universe galaxy when lit up.

In line with the Western aesthetics while retaining the eastern flavor.
Material selection of high strength die-cast aluminum alloy shell.
Modern and simple design is suitable for any scene.



Protection Grade	IP65
Rated Power	30-120W
Input Voltage	110-220vAc
Lifespan	50000hrs

XIANGYUN



XIANGYUN

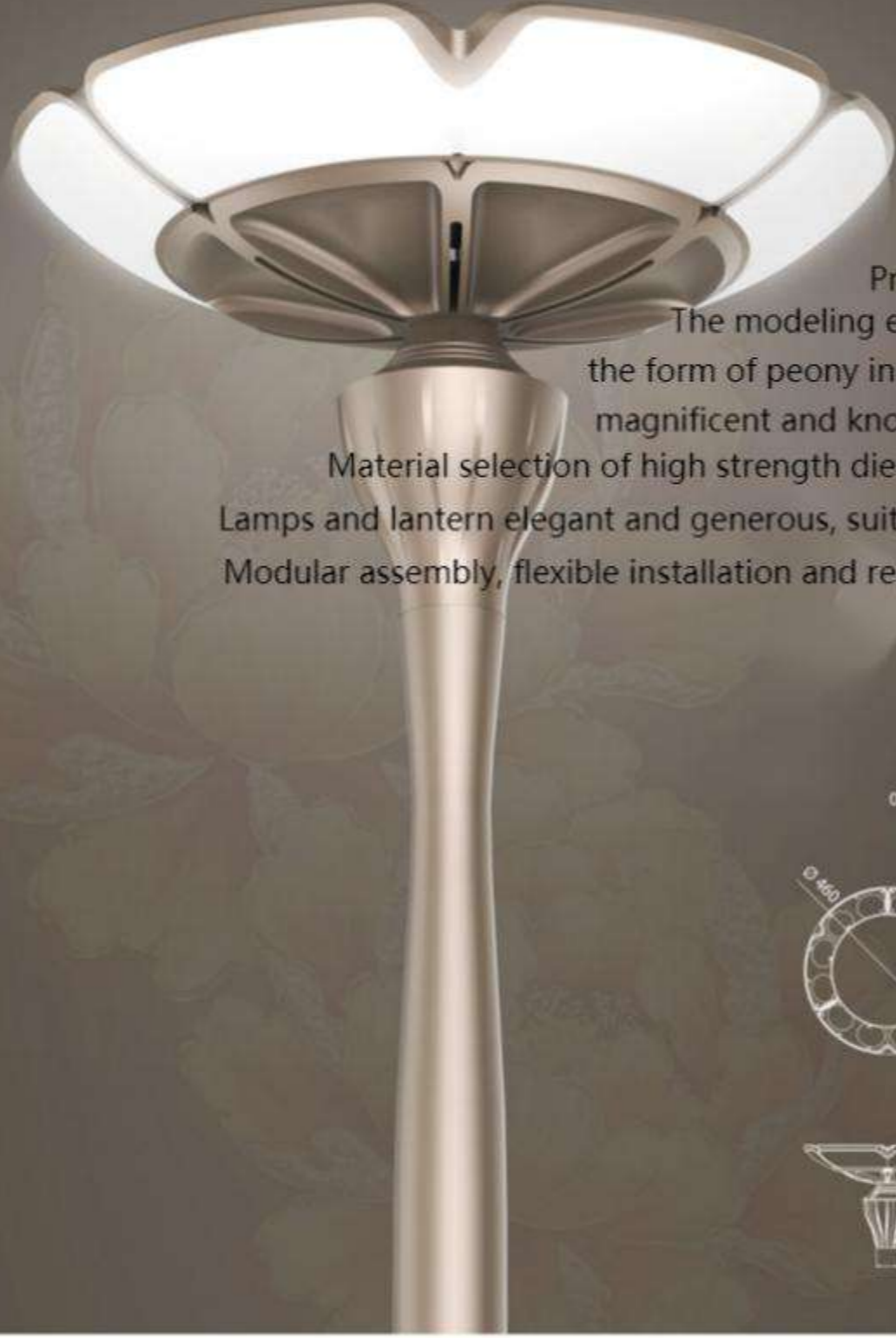

Product characteristics
The modeling elements are extracted from the form of peony in it's heyday. Peony is magnificent and known as the king of flowers. Material selection of high strength die-cast aluminum alloy shell. Lamps and lantern elegant and generous, suitable for all kinds of scenes. Modular assembly, flexible installation and replacement.

Overall Dimensions

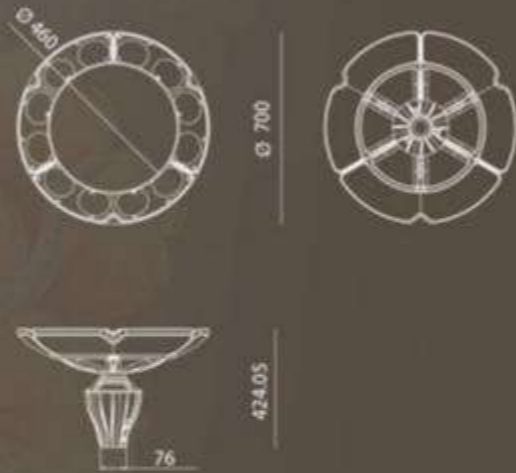

Protection Grade	IP65
Rated Power	60-180W
Input Voltage	110-220vAc
Lifespan	50000hrs

Flourishing Age Peony



Flourishing age peony



Product characteristics

The word "star" to brilliant lights in poetry and literature.
The design of the lamps are simple and charming.

The luminous surface is both the light source and the design point.

When it lights up, it looking like the milky way of the universe, so it named the light of stars.

Material selection of high die-cast aluminum alloy shell.
In line with the western aesthetics while retaining the eastern flavor.

Modern and simple design is suitable for any scene.

Overall Dimensions



Front mounting

Star Light

Protection Grade	IP65
Rated Power	30-100W
Input Voltage	110-220vAc
Lifespan	50000hrs



Star light--front mounting



Product characteristics are the same with front mounting.



Side mounting
Star Light

Protection Grade	IP65
Rated Power	30-100W
Input Voltage	110-220vAc
Lifespan	50000hrs



Star light--side mounting

Overall Dimensions



Light of city--hoisting

Protection Grade	IP65
Rated Power	30-120W
Input Voltage	110-220vAc
Lifespan	50000hrs

Light of City



Light of city--front mounting



Star light--side mounting



Star light--front mounting



The ring module style



Moon ring



Light of city



The light of the milky way



Xiangyuan



Flourishing age peony

Moon light lawn lamp

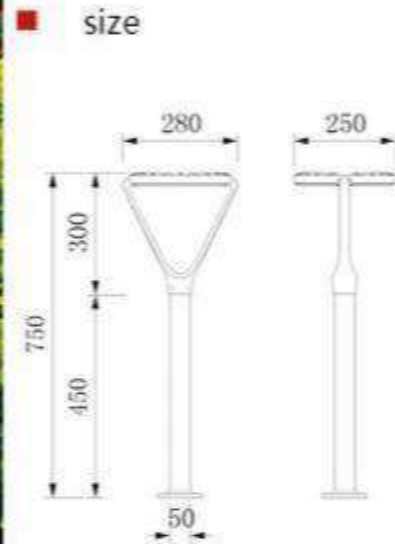

Model: Moon light lawn lamp Light source type: LED Power: 5W-10W Size: L280*W250*H800
 Material: Die-cast aluminum Voltage: < 36W or = 36W Protection grade: IP65

Star Light Lawn Lamp



Model: Star light lawn lamp Light source type: LED Power: 5W-10W Size: L290*W145*H700
 Material: Die-cast aluminum Voltage: < 36W or = 36W Protection grade: IP65



■ Local figure

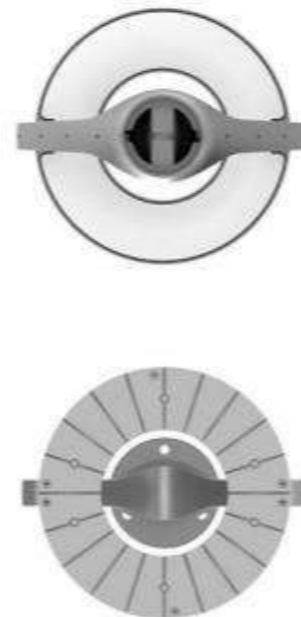

■ Local figure



Cloud light lawn lamp

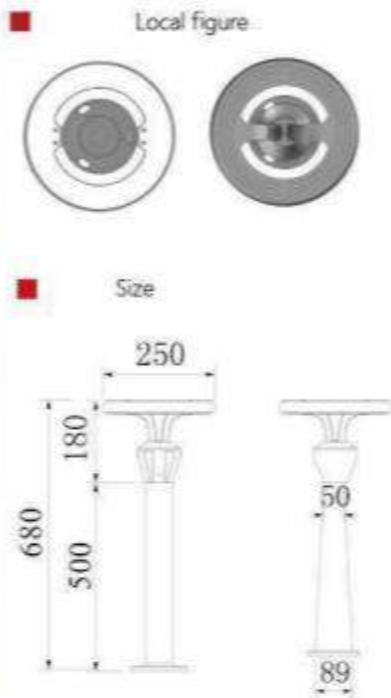

moon ring H750 Power: 5-20W
Straight rod rod diameter:50



moon ring H820 Power: 5-20W
cone rod upper diameter50/lower89



Flourishing peony H680/power 5-20W
Straight rod/rod diameter 60

Model: Peony/Xiangyun lawn lamp Light source type: LED
Power: 5W-10W Size: L280*W250*H800 Material: Die-cast aluminum
Voltage: < 36W or = 36W Protection grade: IP65



Star light H700/power 5-20w
Straight rod/rod diameter 50



Star light H680/power 5-20w
cone rod/upper diameter50/lower89



Flourishing peony H680/power:5-20w
cone rod/upper diameter50/lower89

Peony Lawn Lamp



Xiangyun H680/power: 5-20w
Straight rod/rod diameter 60



Xiangyun H720/power 5-20w
Cone rod/upper diameter50/lower89



Flourishing peony H680/power 5-20w
Cone rod/upper diameter50/lower89